



ISSN: 2707-1146  
e-ISSN: 2709-4189

# Nature & Science

International Scientific Journal



**THE REPUBLIC OF AZERBAIJAN**

# **Nature & Science**

**International Scientific Journal**

**Volume: 6 Issue: 12**

**Baku  
2024**

The journal is included in the register of Press editions of the Ministry of Justice of the Republic of Azerbaijan on 04.07.2019. Registration No. 4243



## International Indices

ISSN: 2707-1146  
e-ISSN: 2709-4189  
DOI: 10.36719



**Editorial address**  
AZ1073, Baku,  
Matbuat Avenue, 529,  
“Azerbaijan” Publishing House,  
6th floor

**Phone:** +994 50 209 59 68  
+994 99 805 67 68  
+994 99 808 67 68  
+994 12 510 63 99

**e-mail**  
nature.science2000@aem.az

© It is necessary to use references while using the journal materials.  
© <https://aem.az>  
© info@aem.az

### **Founder and Editor-in-Chief**

**Researcher Mubariz HUSEYINOV**, Azerbaijan Science Center / Azerbaijan  
+994 50 209 59 68  
tedqiqat1868@gmail.com  
<https://orcid.org/0000-0002-5274-0356>

### **Editor**

**Assoc. Prof. Dr. Akif AGHBABALI**, Baku State University / Azerbaijan  
oruclu@rambler.ru  
<https://orcid.org/0000-0001-5793-9252>

### **Assistant editors**

**Assoc. Prof. Dr. Fuad RZAYEV**, Institute of Zoology of the MSERA / Azerbaijan  
fuad.rzayev01f@gmail.com  
<https://orcid.org/0000-0002-8128-1101>

**Ph. D. Saliga GAZI**, Institute of Zoology of the MSERA / Azerbaijan  
seliqegazi08@gmail.com  
<https://orcid.org/0000-0002-9378-4283>

**Gulnar ALIYEVA**, Azerbaijan Science Center / Azerbaijan  
gulnar.musayeva1982@gmail.com  
<https://orcid.org/0009-0004-1769-777X>

### **Language editor**

**Assoc. Prof. Dr. Gunay RAFIBAYLI**, Baku State University / Azerbaijan

### **Editors in scientific fields**

**Prof. Dr. Ali ZALOV**, Azerbaijan State Pedagogical University / Azerbaijan  
**Assoc. Prof. Abulfaz TAGHIYEV**, Baku State University / Azerbaijan

### **EDITORIAL BOARD**

**Prof. Dr. Irada HUSEYNOVA**, Institute of Molecular Biology and Biotechnology of the MSERA / Azerbaijan  
**Prof. Dr. Nazim MURADOV**, University of Central Florida / USA  
**Prof. Dr. Vagif FARZALIYEV**, Institute of Chemistry of Additives named after M. Guliyev of the MSERA / Azerbaijan  
**Prof. Dr. Georgi DUKA**, Moldovan Academy of Sciences / Moldova  
**Prof. Dr. Ibrahim JAFAROV**, Scientific Research Institute of Plant Protection and Technical Plants of the MARA / Azerbaijan  
**Prof. Dr. Elshad GURBANOV**, Baku State University / Azerbaijan  
**Prof. Dr. Ulduz HASHIMOVA**, Institute of Physiology of the MSERA / Azerbaijan  
**Prof. Dr. Shahana HUSEYNOVA**, Technical University of Berlin / Germany  
**Prof. Dr. Sayyara IBADULLAYEVA**, Institute of Botany of the MSERA / Azerbaijan  
**Prof. Dr. Dunya BABANLI**, Azerbaijan State Oil and Industry University / Azerbaijan  
**Prof. Dr. Mehmet KARATASH**, Nejmettin Erbakan University / Turkey  
**Prof. Dr. Shaig IBRAHIMOV**, Institute of Zoology of the MSERA / Azerbaijan  
**Prof. Dr. Alovzat GULIYEV**, Institute of Soil Science and Agro Chemistry of the MSERA / Azerbaijan  
**Prof. Dr. Rajes KUMAR**, Ministry of Textile / India  
**Assoc. Prof. Dr. Bilal BUSHRA**, Muhammad Ali Jinnah University / Pakistan  
**Assoc. Prof. Dr. Elchin HUSEYN**, Rotterdam Erasmus University Medical Center / Netherlands  
**Dr. Svetlana GORNOVSKAYA**, Beloserkovsk National Agrarian University / Ukraine

<https://doi.org/10.36719/2707-1146/51/4-9>

**Afag Aliyeva**

Nakhchivan State University

Doctor of Philosophy in Biology

afagaliyeva100@gmail.com

<https://orcid.org/0009-0009-8075-9490>

## **Conservation Methods of Some *Brassicaceae* Burnett. Species in the Flora of Nakhchivan Autonomous Republic Considering Global Climate Change**

### **Abstract**

The article discusses the impact of drought on the development of wild species of the *Brassicaceae* Burnett. family in the flora of Nakhchivan Autonomous Republic and the ways to solve this problem. Researches were conducted in the direction of climate change of wild species of the *Brassicaceae* Burnett. family, which are distributed in Babek, Kangarli, Julfa, Ordubad, Shahbuz regions of the Nakhchivan Autonomous Republic, starting from the lowland region to the high mountain arches. The amount of precipitation in the plains is less than in the highlands and the annual temperature is higher. Considering these features, plains have been the center of attention. Plants belonging to the *Brassicaceae* Burnett. family (mostly belonging to the mesophyte type ecological group), which are distributed in water edges, wetlands, meadows and agricultural areas, are exposed to drought stress more than species distributed in other ecological environments. The bioecological and geographical (phenophase, height, life form, ecological group, altitude zone and ecological environment) characteristics of these plants are tabulated. As the effects of drought are expected to increase in the future due to global climate change, more sustainable approaches are recommended in this area.

**Keywords:** *climate change, Brassicaceae Burnett., species, plant, mesophyte*

### **Introduction**

Global climate change has become one of the most pressing economic and political issues in the world (Bondarenko et al., 2018, pp. 84-93). Global climate change is causing long-term changes in the Earth's climatic conditions, with serious impacts on plants as well as other living organisms. Rising temperatures, unusual weather conditions, changes in humidity and more extreme weather events are severely affecting plant growth, reproduction and productivity. Plants play an important role in maintaining the stability of ecosystems and meeting the nutritional needs of humans. In this respect, it is necessary to investigate the impacts of climate change on their life cycles and their role in ecosystems. Increased temperature causes atmospheric drought and over a long period of time can increase evapotranspiration, leading to desiccation of the root-inhabited soil layer and increased salt content (Ergashev, 2010, pp. 64-70). Drought is a natural phenomenon characterized by limited water resources and significantly affects plant growth. Frequent droughts due to increasing global climate change and unusual weather conditions pose a major threat to plant species. Lack of water weakens the development of plant root systems, the absorption of nutrients and the process of photosynthesis, which leads to a decrease in productivity and, as a result, to an imbalance of ecosystems. Living organisms have to relate themselves to the environment for their sustenance. Environmental factors and metabolic processes in the body cause molecules or atoms to form free radicals that have increased chemical reactivity (Kaur, 2013, pp. 1-9). Under the influence of drought, both physical and biochemical changes occur in plants, which negatively affect the food chain and biodiversity. From this point of view, it is more realistic (for Nakhchivan AR) that many plants that exist in nature may disappear completely or be threatened with extinction.

### **Research**

The *Brassicaceae* (*Cruciferae* or mustard family) is a large plant family with approximately 338 genera and 3709 species distributed worldwide, most are distributed in the temperate areas of the Northern Hemisphere (Younes et al., 2015, pp. 1448-1458). *Brassicaceae* Burnett. Cabbage family

is represented by 248 genera and 74 species in Azerbaijan and 67 genera and 165 species in the flora of Nakhchivan Autonomous Republic (Askerov, 2016; Talibov, Ibrahimov, & Ibrahimov, 2021). The family Brassicaceae unites insect-pollinated plants with regular leaves, characterized by the structure of the flower: it consists of 4 sepals, 4 petals alternating with sepals, 6 stamens, of which 2 are shorter than the others, 1 pistil with an upper two-nested ovary (Erzhapova et al., 2010, pp. 36-38). In addition to wild species, cultivated representatives are also known (Aliyeva, 2023, pp. 4-8). The Brassicaceae are an important family for three primary reasons (Koch, Al-Shehbaz, & Mummenhoff, 2003, pp. 151-171). The mustard family (Brassicaceae or Cruciferae) belongs to the order Brassicales and is readily distinguished from other flowering plant families by a cruciform (crossshaped) corolla, six stamens (the outer two shorter than the inner four), a capsule often with a septum and a pungent watery sap (Franzke et al., 2011, pp. 108-116). Numerous studies (e.g. Al-Shehbaz, 1984; Price et al., 1994; Appel and Al-Shehbaz, 2003; Koch et al., 2003a; Mitchell-Olds et al., 2005) have amply demonstrated that morphological characters in the *Brassicaceae* are highly homoplasious, making it virtually impossible to utilize them alone in establishing phylogenetic relationships on a family-wide basis or sometimes even within genera (Al-Shehbaz et al., 2006, pp. 89–120). Representatives of the section grow in different ecological environments of the region. The plant species (genotype) reflects the ecological conditions of the region of its occurrence (Mammadov & Ismayilov, 2012). It is known that due to global climate change (decrease in precipitation and the emergence of drought), water areas have started to decrease. This gives an alarm signal for the aquatic environment and the creatures living around it. Current climatic conditions pose a serious threat to plants growing in the aquatic environment, wetlands and humid parts of the season. Information on the plants in these regions and the bioecological characteristics of the season is given in the table below:

**Table**  
Bioecological and geographical characteristics of *Brassicaceae* Burnett. family species facing extinction due to climate change

№	Species	Height and phenophase	Life form	Ecological group	Elevation zone	Ecological environment
1.	<i>Alliaria petiolata</i> (Bieb.) Cavara & Grande	20-100 cm, IV-V, VI-VIII	Biennial	Mesophyte	To mid-altitude	Forests, scrub edges, parks
2.	<i>Arabis carduchorum</i> Boiss.	2-5 cm V-VI, VI-VII	Perennial	Mesophyte	Alpine height	Grasses
3.	<i>Barbarea minor</i> C.Koch	5-25 (35) cm V-VI (VII), VI-VIII (IX)	Perennial	Mesophyte	From the middle mountain belt to the alpine altitude	Moist meadows, river banks
4.	<i>Barbarea plantaginea</i> DC.	20-60 cm V-VI, VI-VII	Biennial	Mesophyte	High mountain belt	Wet places, small river banks
5.	<i>Barbarea stricta</i> Andrz.	50-100 cm V-VI, VI (VII)	Biennial	Mesophyte	Low and middle mountain belt	River banks, wet forests, meadows, wetlands
6.	<i>Barbarea vulgaris</i> R.Br.	20-70 (100) cm, V-VI, VI-VII	Biennial	Mesophyte	Plains and hills	Grass, damp places, roadsides
7.	<i>Brassica campestris</i> L.	Up to 1 m IV-VII, V-VIII	Annual	Mesophyte	From lowlands to subalpine elevations	Grasslands, orchards, vineyards
8.	<i>Bunias orientalis</i> L.	25-80 (100) cm IV-V (VI), VI-VII	Annual or biennial	Mesophyte	From the lower mountain belt to subalpine elevations	Grasses, meadows and crops
9.	<i>Calepina irregularis</i> (Asso) Thell.	20-60 cm IV-V, V-VI	Annual	Mesophyte	Plains and hills	Places with low humidity

10.	<i>Cardamine uliginosa</i> Bieb.	20-40 (50) cm V-VI (VIII), VI-VIII (IX)	Perennial	Mesophyte	Middle and upper mountain belt	Stony slopes and oases (occasionally)
11.	<i>Draba nemorosa</i> L.	8-30 (60) cm (IV)V-VII (IX), VI-VIII (IX)	Annual	Mesophyte	From subalpine to alpine	Subalpine and alpine meadows, grassy slopes, cultivated areas
12.	<i>Erophila verna</i> (L.) Bess.	2-15 (30) cm III-IV, IV-V	Annual	Mesophyte	From the plains to the central mountain belt	Steppes, grassy slopes, semi-deserts and meadows
13.	<i>Eruca sativa</i> Mill.	20-80 cm IV-V, V-VII	Annual	Mesophyte	Up to the central mountain belt	Cereal crops and pastures
14.	<i>Hesperis Buschiana</i> Tzvel.( <i>H. armena</i> Boiss.)	60-70 cm V-VI	Perennial	Mesophyte	Central highlands	Forest edge, scrub
15.	<i>Hesperis matronalis</i> L.	(15) 30-100 cm V-VI (VII), VI -VII (VIII)	Perennial	Mesophyte	From lowland to subalpine altitude	Forests, meadows, bushes
16.	<i>Lepidium draba</i> L.	16-40 (52) cm, IV-V, V-VI (VII).	Perennial	Mesophyte	Flat and low mountain belt, mostly middle mountain belt	As weeds in fields, plantations, gardens, roads, often in lawns
17.	<i>Lepidium latifolium</i> L.	40-150 cm, VI-VII, VII- VIII	Perennial	Mesophyte	Flat, central mountain belt	Moist, salty meadows, sometimes fields and gardens
18.	<i>Lepidium vesicarium</i> L.	20-40 (60) cm, V-VI, V-VI (VII)	Annual	Mesophyte	flat, low mountainous, rarely mid- mountainous	Wetland, semi-desert, as weeds in fields and plantations, riparian
19.	<i>Myagrurn perfoliatum</i> L.	(10) 20-50 cm IV-V, VI (VIII)	Annual	Mesophyte	From the plains to the central mountain belt	Crops, mostly pastures
20.	<i>Neurotropis armena</i> (N. Busch) Czer.	25-50 cm IV-V, VI-VIII	Annual	Mesophyte	From lowland to high mountain belt	Grassy slopes, forest edges, shrubs and crops
21.	<i>Neurotropis platycarpa</i> (Fisch. & C.A. Mey.) F.K. Mey.	15-35 cm V, VI	Annual	Mesophyte	Medium and high mountain belt	Meadows and grassy areas
22.	<i>Neurotropis Szowitsiana</i> (Boiss.) F.K. Mey.	15-55 cm V-VI, VII-VIII	Annual	Mesophyte	Medium and high mountain belt	Grasses
23.	<i>Noccaea Tatinae</i> (Bordz.) F.K. Mey.	15-40 cm IV-V, VI-VII	Annual	Mesophyte	Medium and high mountain belt	Forest edge
24.	<i>Rorippa austriaca</i> (Crantz) Bess.	30-90 cm V-VI, VI-VII	Perennial	Mesophyte	To the central mountain belt	Wet areas along the coast
25.	<i>Sisymbrium Loeselii</i> L.	20-60 cm, IV- VIII (IX), V-IX (X)	Biennial	Mesophyte	Middle and subalpine mountain belt	Meadows, forest clearings, garbage dumps
26.	<i>Strigosella africana</i> (L.) Botsch.	18-30 cm IV-V, V-VI	Annual	Mesophyte	From lower mountain belt to middle mountain belt	Vacant land and crops, stony slopes
27.	<i>Thlaspi Huetii</i> Boiss.	15-40 cm, IV-VII	Annual	Mesophyte	Central mountain belt, rarely flat	Moist meadows, river banks, grassy areas

As can be seen from the table, species are distributed in wetlands, agricultural lands, river banks, marshes and other water areas. As a result of drought, these species are more likely to disappear in nature. For this reason, it is appropriate to collect the seeds of species and create a “Gene Fund” to protect biodiversity. In order to prevent such a dangerous situation, it is necessary to ensure that the seeds spread in nature at an artificial rate. It is also important that seeds are renewed every year to prevent their germination capacity from decreasing. As we know, under stress plants start and end the vegetation period quickly. Offspring care in stressed plants is stronger than in plants growing under normal conditions. In this respect, seeds should be collected in years when drought is more severe. Stress also affects annuals more than others.

### Conclusion

During the observations, the effects of drought conditions experienced in 2022-2023 on the morphological structure and vegetation periods of plants were also revealed. The mesophytic ecological group of the Burnett family Brassicaceae, which is likely to be most affected by climate change, includes 27 species. Among the wild species belonging to the mesophytic ecological group, 13 species (48.14 %) are annual, 8 species (26.62 %) are perennial, 5 species (15.51 %) are biennial, and one species (3.70 %) are annual or biennial plants.

**Figure 1**

*Lepidium draba* L. (Batabat region 29.06.2022)



**Figure 2**

*Bunias orientalis* L. (Arafsa area of Culfa district 09.06.2022)





**Figure 3**

*Cardamine uliginosa* Bieb. (Khazinedara region 22.05.2022)



**Figure 4**

*Strigosella africana* (L.) Botsch. (Chalhangala region 17.05.2023)



### References

1. Aliyeva, A. M. (2023). On the taxonomic composition of family *Brassicaceae* Burnett, distributed in the flora of Nakhchivan Autonomous Republic of Azerbaijan. *Sciences of Europe* (Praha, Czech Republic), 127, 4-8.
2. Al-Shehbaz, I. A., Beilstein, M. A., & Kellogg, E. A. (2006). Systematics and phylogeny of the Brassicaceae (Cruciferae): an overview. *Systematics and Evolution*, 259, 89–120.
3. Askerov, A. (2016). *Flora of Azerbaijan*. Teas Press.
4. Bondarenko, L. V., Maslova, O. V., Belkina, A. V., & Sukhareva, K. V. (2018). Global climate change and its consequences. *Vestnik REU im. G. V. Plekhanova*, 2(98), 84-93.
5. Ergashev, A. E., Abdullayev, A. A., Karimov, H. H., Ibrahimov, K., & Rakhimov, M. (2010). Effect of soil drought on water exchange in wheat leaves. Reports of the Academy of Sciences of the Republic of Tajikistan. *Plant Physiology*, 53(1), 64-70.
6. Erzhapova, R. S., Iriskhanova, Z. I., Amalova, Z. N., & Lorsanova, Ya. E. (2010). To characterize the family Cruciferous or cabbage (Cruciferae, Brassicaceae) in the flora of the Chechen Republic South of Russia. *Ecology, Development*, 2, 36-38.

7. Franzke, A., Martin, A. L., Al-Shehbaz, I. A., Marcus, A. K., & Mummenhoff, K. (2011). Cabbage family affairs: the evolutionary history of Brassicaceae. *Trends in Plant Science*, 16(2), 108-116.
8. Kaur, T., Hussain, K., Koul, S., Vishwakarma, R., & Vyas, D. (2013). Evaluation of nutritional and antioxidant status of *Lepidium latifolium* Linn.: A Novel Phytofood from Ladakh. *Plos one*, 8(8), 1-9.
9. Koch, M., Al-Shehbaz, I. A., & Mummenhoff, K. (2003). Molecular systematics, evolution and population biology in the mustard family (Brassicaceae). *Annals of the Missouri Botanical Garden*, 90, 151-171.
10. Mammadov, Q. Y., & Ismayilov, M. M. (2012). *Planting* (textbook). East-West.
11. Talibov, T. H., Ibrahimov, A. Sh., & Ibrahimov, A. M. (2021). *Taxonomic spectrum of the flora of Nakhchivan Autonomous Republic* (higher spore plants, open-seeded and closed-seeded plants) (II edition).
12. Younes, K., Merghache, S., Djabou, N., Selles, C., Muselli, A., Tabti, B., & Costa, J. (2015). Chemical Composition and Free Radical Scavenging Activity of Essential Oils and Extracts of Algerian *Cardaria draba* (L.) Desv. *Journal of Essential Oil Bearing Plants*, 18(6), 1448–1458.

Received: 02.09.2024

Revised: 17.10.2024

Accepted: 16.11.2024

Published: 20.12.2024

<https://doi.org/10.36719/2707-1146/51/10-13>

**Shahla Abdullayeva**  
Azerbaijan State Pedagogical University  
Doctor of Philosophy in Biology  
shahla-nasimi@mail.ru  
<https://orcid.org/0000-0003-4869-1835>

## **On the Rhizosphere of Field Crops and Factors Influencing the Dynamics of its Microbiota**

### **Abstract**

There is presented a review of literary sources, which disclosed an importance of rhizosphere being a certain biological buffer regulating interrelations between higher plants and soil and inhabiting soil microorganisms. The main factors influencing indicators of activity of rhizosphere microbiota possessing a complex of useful qualities for plants (converting of nutrient into accessible forms, decomposition of organic materials, increase of resistance to abiotic factors, stimulating a growth, antagonism to phytopathogens, etc.) are considered. The violations of interrelations between plants and their associative microorganisms caused by different factors, including the regulating by human ones – such as cultivation technologies, are able to decrease yield potential of agricultural crops including sunflower. The analytical review certifies the prospects to conduct researches allows determining an impact of agrotechnical methods (sowing dates, seed sowing rates, fertilizer, and chemical and biological plant protection) on changes in qualitative and quantitative composition of microbiota in sunflower rhizosphere and to determine their influence on yield and quality of products.

**Keywords:** *soil microflora, rhizosphere, microbiota, associative symbiosis, sunflower, cultivation technology, soil*

### **Introduction**

Soil is not a physical or chemical system, but primarily a biological and biochemical system, one of the main components of which is soil microflora. Microorganisms play a leading role in the decomposition of plant residues, the synthesis and destruction of humus, the formation of the phytosanitary state of the soil, the accumulation of biologically active substances in it, the fixation of atmospheric nitrogen, etc. In addition, soil microorganisms play an important role in the formation of soil fertility and plant nutrition (Bulgarelli, 2013, pp. 807-838; Balandreau, 2007, pp. 851-859). Higher plants, being the main source of nutrients for the predominant number of microorganisms inhabiting the soil, have a significant impact on microbial cenoses. A special zone is formed around the roots of vegetative plants, in which more favorable conditions for the existence of both plants and microorganisms are created. The number of microbes in the root zone is more significant than in the rest of the soil mass. This is primarily due to the secretion of organic substances from the roots (exoosmosomes) synthesized by plants. In addition, in the zone of abundant accumulation and development of roots, the physical properties of the soil improve: soil particles are more structured, due to which the process of respiration of roots and microorganisms improves, a stable temperature is maintained, moisture is better preserved due to the ability of plant root systems to actively change the humidity of their environment.

### **Research**

Roots also increase the acidity of adjacent soil microlayers (within a few millimeters) by releasing carbon dioxide and H<sup>+</sup> ions. The increased accumulation of microbes in the root soil was first noted by the German agronomist and physiologist Hiltner in 1904. He proposed the term "rhizosphere" (Bakker, 2018, pp. 1178–1180). The rhizosphere is a narrow layer of soil adjacent to the plant roots and directly exposed to root secretions and soil microorganisms, with a thickness of about 2–5 mm in diameter. The boundaries of the rhizosphere depend on the plant species, soil type,

humidity, and a number of other factors (Dobereiner, 2001, pp. 330-350). Ulrich notes that, although morphologically the roots, soil, and microorganisms are clearly separated from each other, there is no functional boundary between them. One of the rhizosphere boundaries is defined relatively clearly and coincides with the root surface, the second is more blurred and, according to various characteristics, is at an uneven distance from the root. For the microbial population, these are fractions of a millimeter, for moisture and mobile nutrients – up to ten millimeters, for gaseous compounds – tens of millimeters. Without a deep understanding of the processes occurring in the soils of the rhizosphere, it is impossible to create sustainable farming systems and solve many environmental problems. In the modern understanding, the rhizosphere is the central component of ecosystems and biogeochemical cycles of chemical elements, the place of interaction between soil, roots, microorganisms and soil fauna (Dinesh, 2010, pp. 252-258). The relationship between plants and rhizosphere microflora is of a separate symbiotrophism nature, that is, they are mutually beneficial to both plants and microorganisms. At the same time, the most intense competition is between representatives of the biota for nutrients (Dessaux, Hinsinger, & Lemanceau, 2009, pp. 1-3).

The most important specific features of soils in the rhizosphere are associated with the continuous flow of root exudates and microbial metabolic products into the soil. The rhizosphere soil is very diverse. The rhizosphere microbiota includes various microorganisms: bacteria, actinomycetes, fungi, algae, yeast, protozoa, phages and other living beings. Bacteria are predominant in the rhizosphere of plants, regardless of their growth conditions and age, mycobacteria are in second place, actinomycetes, fungi, spore-forming bacteria, etc. are present in incomparably smaller quantities (Hartmann, Rothballer, & Schmid, 2008, pp. 179-186; Mendes, Garbeva, & Raaijmakers, 2013, pp. 634-663). Non-spore-forming bacteria constitute the main, most extensive and diverse group of rhizosphere microbiota, their number can reach 99.5 % of the microbial population of the rhizosphere. This group includes representatives of various families, genera and species: Azotobacter, nodule bacteria, thiobacteria, photobacteria, Azotomonas, sulfomonas, nitrifiers, denitrifiers, etc. One gram of soil contains billions of ammonifiers and denitrifiers, while nitrifiers and cellulolytic bacteria are comparatively few. Mycobacteria are in second place in terms of quantity, with their number reaching hundreds of thousands and millions. Spore-forming bacteria make up fractions of a percent in the rhizosphere, and are especially few in number during the period of active plant vegetation, since this group of bacteria develops mainly on dead, decaying roots. Bacteria form strong associations with the root system of plants and form specific rhizosphere bacterial communities. Such relationships are characterized by the terms “associative bacteria”, “associative relationships”, “associative symbiosis” (Philippot, 2013, pp. 789-799).

To maintain the rhizosphere bacterial community, plants lose 30–50 % of the products of photosynthesis in the form of root exudates and rhizodeposits, but this is compensated for by the fact that rhizobacteria perform the following: control of the entry of mineral elements from the soil into the root; binding of gaseous atmospheric nitrogen and improving nitrogen nutrition of plants due to it; synthesis of phytohormones; inhibition of plant growth by various metabolites; consumption and destruction of root secretions of vegetative plants, which has a positive effect on the process of root nutrition; suppression of the activity of microbiota unfavorable for plants; stimulation of endosymbiosis of plants and microorganisms; decomposition of cellulose; synthesis of vitamins, polysaccharides, heteroauxins, and thereby have a certain effect on the development of the plant organism. The function of nitrogen fixation was previously attributed only to a limited range of free-living bacteria — Azotobacter, Clostridium, Azospirillum, Beijerinckia, Derxia. Currently, it is believed that 80-90 % of all known bacteria are capable of fixing nitrogen from the atmosphere, these are representatives of the genera: Azospirillum, Herbaspirillum, Acetobacter, Agrobacterium, Azotobacter, Pseudomonas, Enterobacter, Klebsiella, Burkholderia, Flavobacterium, Campylobacter (Raynaud, 2010, pp. 210-219).

This type of nitrogen fixation is called associative, in contrast to symbiotic, which is typical for bacteria living in the nodules of leguminous plants. This process occurs in almost all types of soil in

the rhizosphere of plants in a wide variety of habitats. A feature of associative bacteria is that they do not form any specialized structures such as nodules on plant roots. The scale of associative nitrogen fixation in the temperate climate zone reaches 50–150 kg/ha of molecular nitrogen during the growing season, in tropical latitudes – from 200 to 600 kg/ha per year, which indicates the great ecological significance of this method of replenishing the fund of nitrogen available to plants in most natural ecosystems. It has been proven that in the soil in the presence of plants, the level of nitrogen fixation is significantly higher than in their absence. Phosphorus is present in the soil in the form of organic (deposits of plant, animal and microbial origin) and inorganic (mineral) compounds, but only about 5 % of it is available to plants, since most of it is in the form of phytin (inositol phosphoric acid salt), nucleic acids, and phospholipids. Rhizospheric bacteria play a significant role in improving the phosphorus nutrition of plants, which, due to the enzymes they synthesize – phytase, nuclease, phosphatase, phospholipase, carry out the mineralization of these compounds with the formation of accessible forms of phosphorus. Under the influence of microflora in the rhizosphere, an increase in the solubility of iron and manganese compounds and other metals is noted, since they are in compounds with organic substances formed by microbes, and therefore are better absorbed by plants. This was confirmed by Weinstein and co-authors in a laboratory experiment with sunflower, where in the absence of microbes and their metabolites, these elements were not absorbed by plants. These observations show that plants absorb iron not in the form of mineral compounds, but in the form of organo-mineral substances formed under the influence of microorganisms. Actinomycetes make up less than 1% of the total number of microorganisms in the rhizosphere and are found mainly towards the end of the plant growing season. The species of actinomycetes living in the rhizosphere and in the soil do not differ in species composition and physiology (Dinesh, 2010, pp. 252-258; Richardson & Simpson, 2011, pp. 41-63).

### **Conclusion**

In Azerbaijan, the main oilseed and most profitable agricultural crop is sunflower. Its production in Russia is carried out on an area of more than 10 million hectares. Highly productive varieties, hybrids and various cultivation technologies are used for sowing, but in production the yield of this crop is realized at best by 50 %. One of the reasons for this is the disruption in the relationship between plants and microorganisms caused by various factors, including those controlled by man – cultivation technologies. At present, in order to move to a highly productive and at the same time environmentally friendly technology for growing sunflower, there is a need to conduct research to establish the impact of agricultural practices (sowing time, seed sowing rate, fertilization, use of chemical and biological plant protection products) on changes in the qualitative and quantitative composition of the microbiota in the rhizosphere of the crop, as well as to determine their impact on the yield and quality of the resulting products. In this case, studying the sunflower rhizosphere will allow us to determine agricultural practices that have a positive effect on its composition, which will allow us to develop technologies that contribute to obtaining high crop productivity.

Understanding and managing the rhizosphere microbiota is vital for improving crop productivity and sustainability. Future research should focus on unraveling microbial functions, enhancing beneficial plant-microbe interactions, and developing precision agriculture techniques to optimize rhizosphere dynamics for various field crops.

## References

1. Bulgarelli, D., Schlaeppli, K., Spaepen, S., Ver Loren van Themaat, E., & Schulze-Lefert, P. (2013). Structure and functions of the bacterial microbiota of plants. *Annual Review of Plant Biology*, 64, 807–838.
2. Balandreau, J. (2007). Microbiology of the association. *Can. J. Microbiol.*, 29(8), 851–859.
3. Bakker, P. A. H. M., Pieterse, C. M. J. & de Jonge, R. (2018). The Soil-Borne Legacy. *Cell*, 172(6), 1178–1180.
4. Dobereiner, J. (2001). A. Lauchli & R. L. Bielecki. (Ed.). Dinitrogen fixation in rhizosphere and phyllosphere associations. *Inorganic Plant Nutrition*, 330–350.
5. Dinesh, R., Srinivasan, V., Hamza, S., Parthasarathy, V. A., & Aipe, K. C. (2010). Physico-chemical, biochemical and microbial properties of the rhizospheric soils of tree species used as supports for black pepper cultivation in the humid tropics. *Geoderma.*, 158, 252-258.
6. Dessaux, Y., Hinsinger, P., & Lemanceau, Ph. (2009). Rhizosphere: so many achievements and even more challenges. *Plant and Soil.*, 321, 1–3.
7. Hartmann, A., Rothballer, M., & Schmid, M. (2008). Plant-driven selection of microbes. *Current Opinion in Biotechnology*, 19(2), 179–186.
8. Igiehon, N. O., Babalola, O. O., & Aremu, B. R. (2019). Genomic insights into plant growth promoting rhizobia capable of enhancing soybean germination under drought stress. *BMC Microbiol.*, 19(1), 1-22.
9. Mendes, R., Garbeva, P., & Raaijmakers, J. M. (2013). The rhizosphere microbiome: significance of plant beneficial, plant pathogenic, and human pathogenic microorganisms. *FEMS Microbiology Reviews*, 37(5), 634-663.
10. Philippot, L., Raaijmakers, J. M., Lemanceau, P., & van der Putten, W. H. (2013). Going back to the roots: the microbial ecology of the rhizosphere. *Nature Reviews Microbiology*, 11, 789–799.
11. Raynaud, X. (2010). Soil properties are key determinants for the development of exudate gradients in a rhizosphere simulation model. *Soil Biology & Biochemistry*, 42, 210-219.
12. Richardson, A. E., & Simpson, R. J. (2011). Soil microorganisms mediating phosphorus availability update on microbial phosphorus. *Plant and Soil*, 1(349), 41–63.

Received: 17.09.2024

Revised: 28.10.2024

Accepted: 11.11.2024

Published: 20.12.2024

<https://doi.org/10.36719/2707-1146/51/14-18>

**Laman Novruzova**

Nakhchivan State University

Doctor of Philosophy in Biology

leman.novruzova.1990@gmail.com

<https://orcid.org/0009-0008-4269-3219>

**Lala Hasanli**

Nakhchivan State University

Ph. D. candidate

lale.alimli@gmail.com

<https://orcid.org/0009-0003-3169-1285>

**Gadir Aliyev**

Nakhchivan State University

qadir.aliyev61@gmail.com

<https://orcid.org/0009-0002-6765-9099>

## **Cytomegalovirus (CMV) in Pregnant Women in Nakhchivan Autonomous Republic**

### **Abstract**

Cytomegalovirus (CMV) hominis virus, belonging to the Herpesviridae family, is widespread in all societies around the world, and in developing countries, most people encounter CMV in early childhood. It is second place after HIV in developing countries.

Anthroponosis is a disease. The source of the disease is those who carry the virus or are sick with one or another form of the disease. Agents are found in blood, saliva, cervical, vaginal secretions, eye drops, sperm, amniotic and cerebrospinal fluid, breast milk, feces. Infection occurs with these specified biological materials and secretions, as well as with transplants. The main infection mechanism is aspiration, it is transmitted by airborne droplets. There is a 25 % chance of transmission from mother to fetus through sexual contact.

Seasonality is not characteristic of the disease. The immunoresistance of CMV is striking. So, despite the presence of antibodies against it, CMVs can circulate in the human body and pass to other people and to the fetus in pregnant women. Persistence and multiplication of viruses in the body without showing symptoms causes the infected person to remain a virus carrier throughout his life. Cellular immunity plays a key role in the pathogenesis of CMV infection. Therefore, this infection is considered an indicator of cellular immunity deficiency. It should be noted that latent CMV infection in pregnant women does not always lead to fetal infection.

**Keywords:** *cytomegalovirus, causative agent, prevalence index, types, age range*

### **Introduction**

Cytomegalovirus (CMV), an enveloped double stranded DNA herpes virus is the most common congenital viral infection. It is also known as human herpesvirus 5 (HHV-5) and like other herpes viruses it becomes latent after a primary infection but can reactivate with renewed viral shedding or from a new strain (Manicklal et al., 2013, pp. 86-102). A recently published systematic review and meta-analysis estimated a global CMV seroprevalence of 83 % in the general population, 86 % in women of childbearing age, and 86 % in donors of blood or organs. For each of these three groups, the highest seroprevalence was seen in the World Health Organisation (WHO) Eastern Mediterranean region (90 %) and the lowest in WHO European region 66 % (Osric et al., 2021, pp. 216-222). The contamination of women during pregnancy, which is the most common cause of intrauterine infection, leads to fetal and infant development deficits (Wen et al., 2002, pp. 111-116).

## Research

Cytomegalovirus (CMV) is the second most common cause of congenital viral infections in the developing countries, after HIV.

This is an anthroponosis. The source of the disease is carriers of the virus or patients with one or another form of the disease. Pathogens are found in blood, saliva, cervical and vaginal secretions, tears, sperm, amniotic and cerebrospinal fluid, breast milk, and feces. Infection occurs with these biological materials and secretions, as well as transplants. The main mechanism of infection is aspiration, transmitted by airborne droplets. Contact, sexual, transplacental transmission from mother to fetus or infection of the fetus in the birth canal are possible. The probability of transmission from mother to fetus is 25 % (Asher et al., 2006, pp. 399-409).

The disease has no seasonality. The immunoresistance of CMV is amazing. Thus, despite the presence of antibodies to it, CMV can circulate in the human body and be transmitted to other people and the fetus in pregnant women. Persistence – the reproduction of viruses in the body without manifestation of symptoms – causes the infected person to remain a virus carrier throughout his/her life. Cellular immunity plays a key role in the pathogenesis of CMV. Therefore, this infection is considered an indicator of cellular immunity deficiency. It should be noted that latent CMV in pregnant women does not always lead to fetal infection (Mussi-Pinhata et al., 2009, pp. 522–528).

Exacerbation of latent infection, and development of viremia increase the probability of fetal infection. The probability of fetal infection is higher during pregnancy. Thus, the absence of antibodies to the virus in the mother's blood and, as a result, its inability to be transmitted to the fetus, as well as viremia developing as a result of fresh infection, contribute to the transmission of infection to the fetus (Boppana, 2006, pp. 73–86).

## Methods

We conducted a systematic literature search for this narrative review summarizing the seroprevalence/prevalence of CMV and associated risk factors among pregnant women (Cannon, Hyde, & Schmid, 2011, pp. 240-55).

The absence of characteristic symptoms of cytomegalovirus infection makes its clinical diagnosis difficult. Therefore, laboratory tests are the main diagnostic method.

Currently, the following methods are used to diagnose cytomegalovirus infection:

- Cultural – material taken from biological fluids is cultured in a special nutrient medium;
- PCR – allows detecting even a small amount of viral DNA in the examined material (urethral, vaginal, cervical swabs, urine, blood, cerebrospinal fluid or saliva);
- IFA – the most widely used method based on the detection of specific antibodies formed against the virus in the blood;
- Cytological method – the examined material (tissues taken by biopsy) is examined under a microscope.

In everyday clinical practice, the IFA method is mainly used. This inexpensive and relatively technically simple examination is carried out using special automatic devices. It can be carried out as often as necessary, which significantly facilitates dynamic monitoring of the course of the infectious process.

## IFA Resolution

IFA determines the titer of immunoglobulins M and G (Ig M and Ig G) in the blood. These are different classes of specific protective antibodies produced by immune cells. If the analysis for cytomegalovirus during pregnancy is positive, the ratio of these antibodies is necessarily assessed (Zuhair et al., 2019).

Detection of IgM in the blood indicates that an active infectious process is currently occurring in the body (Sahiner et al., 2015, pp. 465-471).

This requires choosing a treatment tactic, and in the case of pregnancy, assessing the risks to the fetus. Detection of IgG indicates good immunity. They are formed soon after infection and persist for life. It is the antibodies of this class that reliably protect the body from viruses, preventing their reproduction and spread. If IgM is positive against the background of a questionable IgG result, this



indicates the presence of the first – initial stage of infection. If the Ig M titer is not too high, and the G level, on the contrary, is good – this is a sign of reactivation of a chronic infection. If only Ig G is positive, an inactive phase of the disease is diagnosed – remission (Kenneson & Cannon, 2007, pp. 253-76).

The duration of the disease has prognostic significance. If a woman has chronic activation of cytomegalovirus during pregnancy, the antibodies currently present will prevent its spread. In this case, the risk of intrauterine infection of the fetus is only 3-5 %. With a fresh infection, the transmission of the virus from the placenta to the fetus reaches almost 60 %, which is explained by the lack of antibodies capable of blocking the pathogen.

ELISA does not always provide the necessary information to determine the duration of the infection. A more accurate result can be obtained by determining the avidity of the detected G antibodies to cytomegalovirus, which determines the strength of antibodies' adhesion to viral antigens.

The more stable the resulting immune complexes are, the more time has passed since the infection. Avidity over 35 % indicates that more than 3 months have passed since the infection. An indicator over 50-60 % is considered transitional, indicating the transition of the disease to the chronic phase. High-avidity antibodies are a sign of carriage or chronic infection.

We conducted our study on 94 pregnant women. Of these, Ig M was detected in 2 patients, and Ig G in 92 patients (Diagram 1).

**Diagram 1**

The distribution area by region is shown in the diagram 2 below

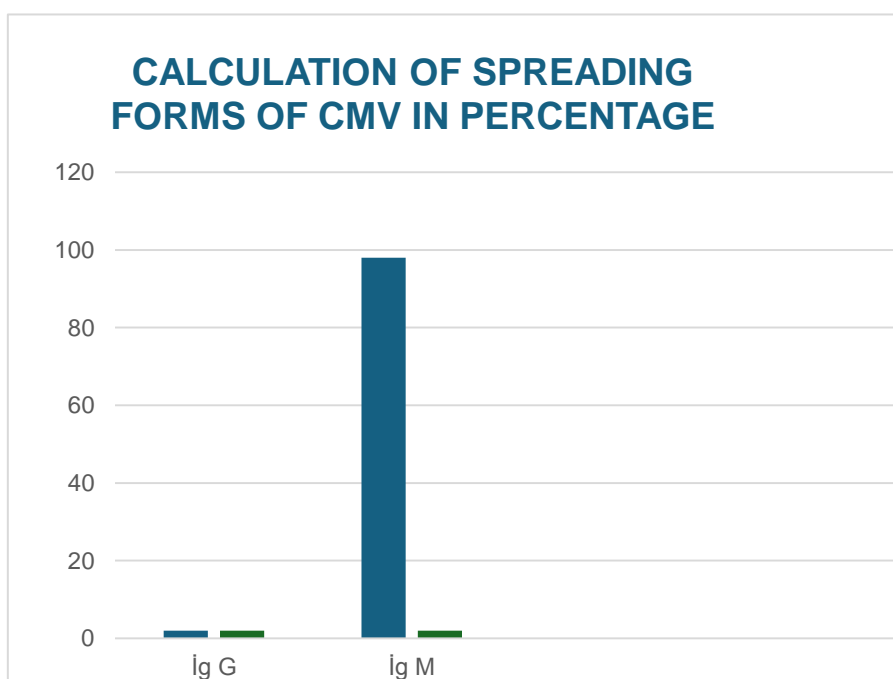

### Diagram 2

In our study, we determined the most recent age intervals in which it is more common (Diagram 3)

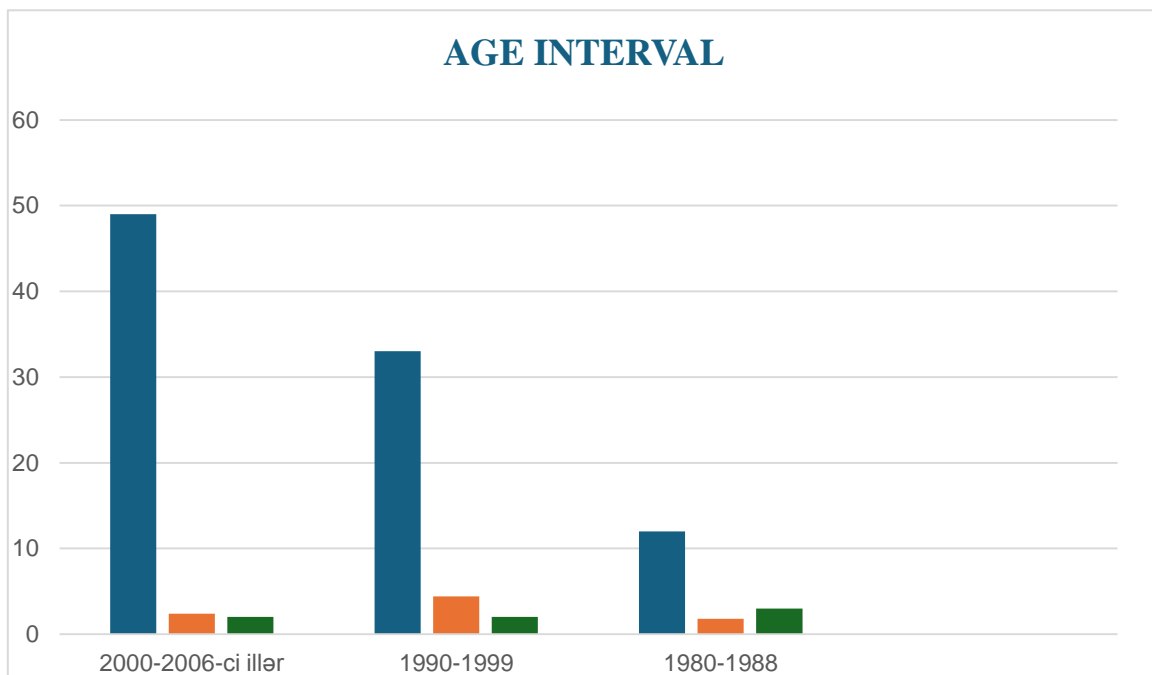
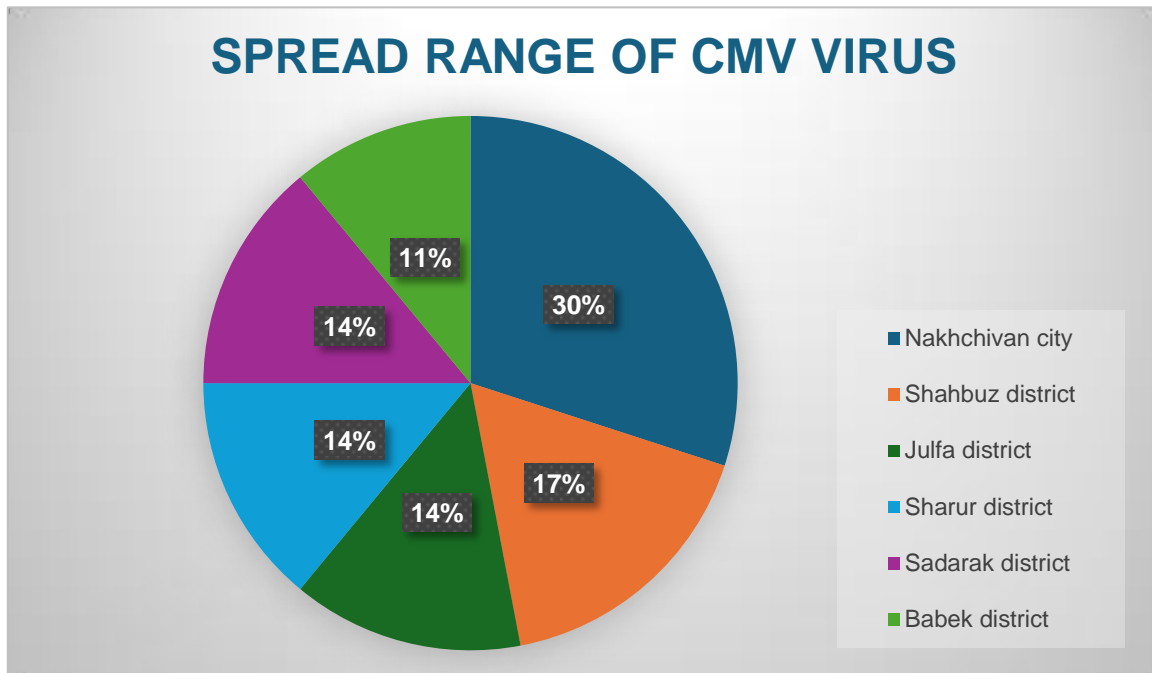

Infection of pregnant women with cytomegalovirus is not a rare occurrence. However, despite the widespread prevalence of the disease among our young women and the ease of testing, most women do not know that they have this disease and inadequately assess the risks to the future child (Permar, Schleiss, & Plotkin, 2018).

Although cytomegalovirus is included in the TORCH group of infections, even a new infection of a pregnant woman does not lead to serious damage to the fetus. Moreover, if cytomegalovirus is treated in the early stages of pregnancy, the infection quickly goes into an inactive phase and damage to the fetus does not occur.

## Conclusion

The aim of the study was to conduct a statistical analysis of the age of young mothers infected with cytomegalovirus in Nakhchivan city and districts of the Nakhchivan Autonomous Republic. As a result, it was revealed that pregnant women aged 18-24 are more common in Nakhchivan city. The course of pregnancies of these pregnant women will be monitored and analyzed.

## References

1. Asher Ornoy, & Orna Diav-Citrin. (2006). Fetal effects of primary and secondary cytomegalovirus infection in pregnancy. *Reproductive Toxicology*, 21(4), 399-409.
2. Boppana, S. B. (2006). In Hutto C (ed), Congenital and Perinatal Infections. *Cytomegalovirus*, 73-86.
3. Cannon, M. J., Hyde, T. B., & Schmid, D. S. (2011). Review of cytomegalovirus shedding in bodily fluids and relevance to congenital cytomegalovirus infection. *Rev. Med. Virol.*, 21(4), 240-55.
4. Doreen Mhandire, Sarah Rowland, Kudakwashe Mhandire, Mamadou Kaba, & Collet Dandara. (2006). Epidemiology of Cytomegalovirus among pregnant women in Africa. *Reprod. Toxicol.*
5. Kenneson, A., & Cannon, M. J. (2007). Review and meta-analysis of the epidemiology of congenital cytomegalovirus (CMV) infection. *Rev. Med. Virol.*, 17(4), 253-76.
6. Manicklal, S., Emery, V. C., Lazzarotto, T., Boppana, S. B., & Gupta, R. K. (2013). The “silent” global burden of congenital cytomegalovirus. *Clin. Microbiol. Rev.*, 26(1), 86-102.
7. Mussi-Pinhata, M. M., Yamamoto, A. Y., Moura Brito, R. M., de Lima Isaac, M., de Carvalho e Oliveira, P. F., Boppana, S., & Britt, W. J. (2009). Birth prevalence and natural history of congenital cytomegalovirus infection in a highly seroimmune population. *Clin. Infect. Dis.*, 49, 522–528.
8. Osrlic, B., Navti, Mariam Al-Belushi, & Justin, C. Konje. (2021). FRCOG. *Cytomegalovirus infection in pregnancy – An update*, 258, 216-222.
9. Permar, S. R., Schleiss, M. R., & Plotkin, S. A. (2018). Advancing our understanding of protective maternal immunity as a guide for development of vaccines to reduce congenital cytomegalovirus infections. *J. Virol.*, 92(7), e00030-18.
10. Sahiner, F., Cekmez, F., Cetinkaya, M., Kaya, G., Kalayci, T., & Gunes, O., et al. (2015). Congenital cytomegalovirus infections and glycoprotein B genotypes in live-born infants: a prevalence study in Turkey. *Infect. Dis. (Lond)*, 47(7), 465-471.
11. Wen, L. Z., Xing, W., Liu, L. Q., Ao, L. M., Chen, S. H., & Zeng, W. J. (2002). Cytomegalovirus infection in pregnancy. *International Journal of Gynecology & Obstetrics*, 79(2), 111-116.
12. Zuhair, M., Smit, G. S. A., Wallis, G., Jabbar, F., Smith, C., & Devleeschauwer, B., et al. (2019). Estimation of the worldwide seroprevalence of cytomegalovirus: a systematic review and meta-analysis. *Rev. Med. Virol.*, 29(3), e2034.

Received: 03.10.2024

Revised: 26.10.2024

Accepted: 18.11.2024

Published: 20.12.2024

<https://doi.org/10.36719/2707-1146/51/19-26>

**Elmira Aliyeva**

Institute of Catalysis and Inorganic Chemistry named by academician of M. Nagiyev

Ph. D. student

[elmiraaliyeva84@gmail.com](mailto:elmiraaliyeva84@gmail.com)

<https://orcid.org/0009-0008-2767-3949>

**Nizami Zeynalov**

Institute of Catalysis and Inorganic Chemistry named by academician of M. Nagiyev

Doctor of Chemistry

[zeynalovnizami3@gmail.com](mailto:zeynalovnizami3@gmail.com)

<https://orcid.org/0000-0002-7889-6594>

## Investigation of the Properties of Smart Polymers and their Application

### Abstract

Today's rapidly developing technology, new and interesting materials are emerging. One of these materials is smart polymers. Smart polymers are polymer materials with special molecular structures that respond to different external effects and change shape. These polymers can change in shape, volume, or other properties in response to environmental changes. The most striking feature of smart polymers is their ability to respond directly to environmental stimuli. The shape-changing abilities of smart polymers usually occur depending on environmental factors such as heat, humidity, pH value, light or electricity. This occurs when the bonds within the polymer molecules undergo structural changes. The areas of use of smart polymers are quite wide. They play an important role in many industries such as medicine, textile, automotive, electronics and energy. Interest in smart polymers, which are frequently used in the development of drug delivery systems, biomaterials and smart materials, is increasing. Taking these into account, the presented review provides information on smart polymers, their properties and application areas.

**Keywords:** *smart polymers, properties, application, drug delivery systems*

### Introduction

The ability of materials to sense and respond to changes in their environment has captivated researchers for years, driving the innovation of smart materials. Among these, smart hydrogels with responsive properties and improved mechanical characteristics have become a major area of research and have found applications across numerous fields (Moses et al., 2024).

### Research

In order for a material to be classified as a smart material, the material must have the ability to respond to environmental stimuli (heat, temperature, mechanical and magnetic) and change its performance or properties accordingly, the material's responses to stimuli must be explainable, understandable and predictable, it must be able to exchange energy (emitting light, generating electricity and being able to change energy) and it must have reversibility (the change in the quality and phase of the material and this change can be reversed) (Aguilar et al., 2019; Bahl et al., 2020). Smart materials are an attractive class of materials for advanced applications today due to the advantages partially mentioned above (Aguilar, 2007). Materials that can change their properties according to the environment and have sensory capabilities, can automatically repair themselves, can change shape with heat or can instantly change phase when a magnetic field is applied, piezoelectric materials (sensors and actuators), shape memory alloys, magneto-rheological materials and electro-rheostat materials are examples of applications where smart materials are used (Bahl et al., 2020). Although they have many applications, there is no widely accepted classification system for the classification of smart materials that is used academically and commercially. As new areas of use emerge, these materials are included in the smart material class. Today, thermoelectrics, multiferroics, magnetocaloric materials, magnetorheological and electrorheological fluids, shape memory materials, thermo and light sensitive polymers have been added to the smart material class. In addition, polymer gels that can change their volume hundreds of times with a small change in

external conditions such as temperature, solvent composition, pH are also considered smart materials (Tüylek, 2019). The features that can be given as examples for a polymer to be defined as a smart material are; reacting to environmental stimuli (external factors such as temperature, humidity, pH, light intensity, electrical or magnetic field, etc.), changing its color or transparency, becoming conductive or water permeable, or responding to this reaction by changing its shape. The response rate of smart polymers can be controlled by the intensity of functional stimuli. The change and control of the physicochemical properties of smart polymers are preferred for their use in different applications and for the regulation of desired properties (Meng & Li, 2013; Zhuang et al., 2013; Peng et al., 2011; Derya & Idris, 2023).

There is no standard definition used to describe smart materials. The most widely accepted definition for smart materials is that a material changes one or more of its properties in a predictable and useful way in response to an external stimulus (Chung et al., 2012). The term smart materials, also called intelligent materials or active materials, refers to a group of materials with unique properties (Qiu & Park, 2011). According to Addington and Schodeck (Nakayama et al., 2006) whether a material is a smart material or not:

- Immediacy: Responding to stimuli in real time
- Temporality: Responding to multiple environmental conditions
- Self-activation: Intelligence is not external to the material, but internal to it
- Selectivity: Responses to stimuli are discrete and predictable
- Directness: Local activation of responses to stimuli can be distinguished by examining.

### **Smart Polymers**

Smart polymers have gained increasing attention and have seen significant advancements in recent years. These adaptable materials are capable of changing their properties when exposed to different external stimuli. The foundation of smart polymer research was laid in the late 1950s when J. F. Katchalsky and P. Eisenberg created the first synthetic hydrogel (Kuhn et al., 1950). This hydrogel demonstrated the ability to swell or contract depending on the pH and ionic strength of the surrounding solution. This breakthrough marked the beginning of smart polymer studies, which have since evolved to encompass a wide range of applications.

Smart polymers are specialized materials with unique molecular structures that react to various external influences by altering their shape. These polymers can adjust their shape, size, or other properties in response to environmental changes. Their most remarkable characteristic is their capacity to respond directly to stimuli from their surroundings. The ability of smart polymers to change shape is typically triggered by environmental factors such as temperature, humidity, pH levels, light, or electrical signals. This behavior occurs due to structural changes in the bonds within the polymer molecules. For instance, a smart polymer subjected to heat may expand or contract as the temperature rises (Arash Fattah-alhosseini et al., 2024).

### **Smart Polymers Types**

Considering the different usage and application areas and polymer types, it is quite difficult to classify smart polymers. However, considering the scientific studies and usage areas conducted to date, it is possible to examine smart polymers under four basic headings as shown in Figure 1. Accordingly, smart polymers can be classified as smart polymeric gels, shape memory polymers, self-healing polymers and stimuli-responsive polymers. Although such a classification method was chosen to make the subject more understandable, smart polymers are actually materials that have very strong interactions with each other and some similar properties.

**Figure 1**  
Smart Polymers Types

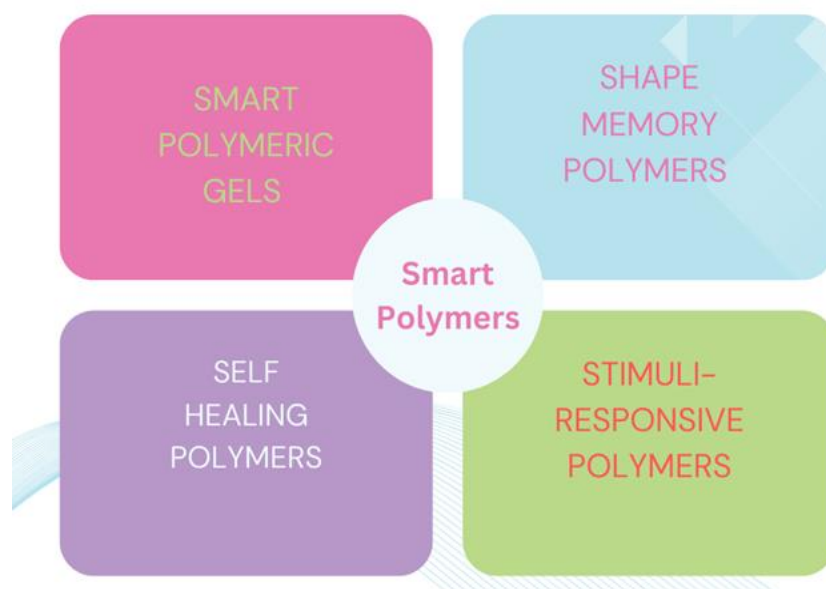

### Smart Polymeric Gels

Hydrogels are polymers with a three-dimensional network structure that can be physically or chemically cross-linked. Hydrogels can also be defined as three-dimensional (3D) natural or synthetic polymeric networks that absorb large amounts of water, up to thousands of times their dry weight in water, without dissolving the polymer due to their hydrophilic but cross-linked structures (Yang et al., 2013). In order for a gel to be defined as a hydrogel, it must be able to absorb at least 20 % of its own weight in water (Priya et al., 2014). In general, hydrogels do not dissolve when they interact with water and swell by taking in the solvent. This is due to the presence of hydrophilic groups in the polymer chain and the porous structure in the form of a network (Ganesh et al., 2014). With their water retention capacity, soft and flexible structures, hydrogels are similar to living tissues. The most important advantages of hydrogels are that they are permeable to water-soluble substances, compatible with the human body, soft and have low friction when swollen with water, can be used in drug delivery systems, and have high water retention capacities. In addition, the weak mechanical strength of hydrogels restricts their use in areas requiring strength (such as bone tissue) (Shalla & Bhat, 2021). The areas of use of hydrogels can be listed as contact lenses, artificial tendon materials, biosensors, surface coating materials, artificial muscle, artificial skin, drug delivery systems, aesthetic surgery, smart irrigation systems in agriculture, heavy metal removal, etc. (Yang et al., 2013; Bauri et al., 2018; Arash Fattah-alhosseini et al., 2024). Smart hydrogels are defined as hydrogels that undergo sudden reversible volume phase transitions or sol-gel phase transitions in response to small external changes (stimuli) in environmental conditions. Compared to traditional hydrogels, smart hydrogels respond faster to these reactions. There are many different classification methods for smart hydrogels in the literature. Polymers with responsive systems exhibit significant property changes when exposed to specific stimuli. These stimuli can impact the polymer chains by altering attributes like hydrophilicity, shape, solubility, degradation, or even triggering bond cleavage (Aguilar & San Rom, 2019). Such transformations directly affect the structural behavior of the polymers. The stimuli can be classified as chemical, physical, or biological. Physical stimuli, such as temperature, light, or electrical signals, often influence the motion of polymer chains. In contrast, chemical stimuli like pH, ionic strength, or redox conditions modify the interactions between polymers and solvents or other polymeric structures. Biological stimuli, including enzyme activity and glucose response, involve molecular processes such as enzyme catalysis or receptor-mediated molecule recognition (Shalla et al., 2021; Aguilar & San Rom, 2019; Bauri et al., 2018; Arash Fattah-alhosseini et al., 2024; Wei et al., 2017).

Polymers that respond to more than one type of stimulus simultaneously are referred to as dual stimuli-responsive polymers. Stimuli-sensitive smart hydrogels Stimuli-responsive polymers are smart polymers that respond to external parameters such as temperature mechanical stress magnetic/electric field humidity fluctuations, pH some small molecules (CO<sub>2</sub> etc.) and some biomolecules (glucose etc.). The response to external stimuli can be a physical or chemical change in the shape, color and solubility of the polymer. Such smart polymers have potential applications in many fields of biology and medicine. For example; they are widely used as sensors and biosensors in controlled drug delivery in environmental remediation and in chemo-mechanical actuators (Derya & Idris, 2023). Light sensitive smart hydrogels Apart from temperature, studies are also being conducted on light and pH sensitive types of stimuli responsive polymers. For example; pH sensitive polymers with ionizable functional groups have the ability to donate or accept protons depending on environmental pH changes. Some common examples are acrylic acid (AAc) (Connal et al., 2008; Kim et al., 2004) and N,N-dimethylaminoethyl methacrylate (DMAEMA) (Liu et al., 2008; Zhang et al., 2017). Light sensitive monomers can also be used to produce materials that exhibit both temperature and light sensitivity. A common example is azobenzene (Gohy & Zhao, 2013; Jochum & Theato, 2013). In most cases, the response of these polymers occurs by light-induced isomerization or light-induced ionization of the light-sensitive molecules incorporated into the polymer. Similarly; Bioresponsive systems can also be used to produce polymers that have the ability to respond to stimuli naturally present in biological structures, such as enzymes and glucose (Derya & Idris, 2023). pH-sensitive smart hydrogels pH-sensitive polymers are polyelectrolyte structures containing ionizable groups in their backbone structures. They have the ability to change their volume in response to a change in the pH of the environment they are in. They can accept or release protons in response to environmental pH changes. They can detect very small pH changes (up to 10<sup>-5</sup> pH) within minutes and swell significantly with high sensitivity (Riaz et al., 2019; Zhao et al., 2018). The degree of ionization (pKa or pKb) of a pH-sensitive hydrogel changes with changes in pH. This change in the net charge of the polymer chain causes the hydrogel to undergo volume deformation due to electrostatic repulsive forces, which creates a large osmotic swelling force. The main phenomenon governing the process is the ability to dissociate and associate hydrogen ions due to pH changes in the aqueous environment. Since this protonation–deprotonation is reversible, the hydrogel swelling–shrinkage can be easily reversed by changing the pH of the ambient solution (Derya & Idris, 2023). Natural pH-responsive polymers, as well as multi-responsive polymers, have garnered significant attention in recent years (Dai et al., 2008).

#### **Application of Smart Polymers**

Smart polymers are a type of material that has developed rapidly in recent years and provides many advantages. These polymers can behave in a special way by reacting to environmental conditions or external effects. With these features, smart polymers used in many areas have many advantages. One of the primary advantages is that smart polymers have a shape memory feature. In other words, they can return to their original shape if they are deformed. This feature is very useful in many industrial applications. For example, smart polymers used in the healthcare sector are used in the production of prostheses or orthoses, providing patients with a better quality of life. Another advantage of smart polymers is their ability to respond to various stimuli. They can perform the desired function by responding to various stimuli such as heat, pH, electrical stimuli or chemical substances. Thanks to these features, smart polymers can be used in many areas such as drug delivery systems, controllable coatings or sensors. Another advantage of smart polymers is their diversity in areas of use. These polymers are used in many sectors from the textile industry to electronics, from the automotive sector to energy storage systems. For example, smart polymers used in the automotive sector can increase fuel efficiency and save energy by improving the aerodynamic properties of vehicles.

Smart polymers are a special class of polymers that can respond to chemical or physical stimuli. The working principle of these polymers is due to changes in their molecular structure. Side chains, which are usually attached to natural or synthetic polymer chains, undergo conformational changes

when exposed to various effects. As a result of these changes, polymer molecules respond in a specific way and perform the desired function. The working mechanisms of smart polymers include various stimuli such as thermal, pH, light, electrochemical and magnetic interactions. For example, thermal stimulation occurs when polymers respond to heat. In this case, polymer molecules undergo conformational changes and change shape in a specific way when heated. Similarly, polymers can expand or shrink by undergoing proton exchange reactions with pH stimulation (Derya & Idris, 2023).

Smart polymers are capable of delivering drugs to targeted cells or tissues within the body. Similarly, pH-responsive polymers can be utilized to develop pH-sensitive hydrogels that release drugs at predetermined pH conditions. Smart polymers enable the development of targeted drug delivery systems, allowing medications to be delivered directly to the specific cells or tissues in need. This approach enhances treatment efficacy while minimizing drug side effects. Furthermore, smart polymers can be utilized to design implantable devices that respond to physiological changes, such as variations in temperature or pH (Derya & Idris, 2023).

**Drug Delivery Systems** – When an enzyme is immobilized with smart hydrogels, the products of the enzymatic reaction can trigger the phase transition of the gel. Thus, in the presence of the substrate, it is possible to convert the chemical signal into an environmental signal (e.g. pH change) and then into a mechanical signal called swelling or shrinkage of the smart gel. Such systems are used in biomimetic actuators on the one hand and contribute to the development of drug delivery systems on the other. The development of a glucose-sensitive, insulin-secreting system for the treatment of diabetes has long been a problem for biomedical engineers. To solve this problem, smart polymer systems are used. An example of such systems is the development of drug delivery systems where drug distribution is free in response to a chemical signal (insulin release in response to increasing glucose concentration). Since the diffusion of the drug through the polymer varies according to the state of the gel, the swelling or shrinkage behavior of smart polymers in response to small changes in pH or temperature can be successfully used to control drug release (Bengi Ozkahraman, 2014).

Smart polymer-based materials, by intelligently responding to external stimuli, offer various applications and enable their use in modern pharmaceutical research (Avinash Kumar et al., 2024). The intelligent behavior of these polymers enables their application in many fields, including drug delivery, tissue engineering, tissue repair, and various sensors (Deepti Bharti et al., 2023). The stimulus-responsive properties, shape memory behavior, and self-healing capabilities of smart polymeric materials are crucial characteristics for applications in tissue engineering, medical devices, and cell therapy. Smart polymeric materials offer significant potential for advancing precision medicine by addressing the “temporal,” “spatial,” and “personal” dimensions. To meet the temporal aspect, these materials enable the creation of innovative biodegradable or biocompatible scaffolds. Their design also supports the development of injectable self-healing hydrogels and controlled-release drug delivery systems, which are essential for achieving spatial precision. Moreover, 3D printing with bioinks containing a patient’s stem cells serves as a key fabrication method, integrating smart polymeric materials with cell therapy to fulfill the personal dimension. Overall, the advancement of smart polymeric materials is pivotal in uniting these three aspects to support cell therapy and precision medicine (Hung-Jin Huang et al., 2019).

The evolving needs of society call for innovative products that enhance daily life. In polymer chemistry, this demand is met by smart materials. Advancing this area of polymer science enables better alignment with societal requirements. The demonstrated applications of these materials highlight their potential to revolutionize numerous industries. The growing interest among scientific communities in this field has been evident for many years (Alicja Balcerak et al., 2024).



## Conclusion

Recently, smart polymers have been widely applied in many fields, including drug delivery, tissue engineering, tissue repair, and various sensors. In particular, smart polymers in drug delivery systems show exceptional potential in achieving controlled and targeted profiles, ensuring drug delivery to specific receptors, and minimizing off-target effects. Smart polymers are a class that differs from ordinary polymers by their rapid change in their physico-chemical state in response to the external environment. The main issue here is their tunable structural and functional potential. The classification of these polymers is based on different environmental effects. This includes temperature, pH, light, enzymatic reaction, pressure, electric/magnetic field, etc. Includes. Note that the properties of these polymers can be changed during polymer synthesis by changing the chain structure, and at the same time, smart polymers have the ability to strongly react to relatively weak external influences.

Thus, the synthesis of smart polymers depending on various factors and their wide application in industry have been studied.

## References

1. Alicja Balcerak-Woźniak, Monika Dzwonkowska-Zarzycka & Janina Kabatc-Borcz. (2024). Comprehensive Review of Stimuli-Responsive Smart Polymer Materials-Recent Advances and Future Perspectives. *Materials*, 17, 4255. <https://doi.org/10.3390/ma17174255>
2. Aguilar, M. R., Román, J. S., & Eds, J. (2019). *Smart polymers and their applications* (Second edition). Woodhead Publishing is an imprint of Elsevier.
3. Aguilar, M. R., & San Román, J. (2019). Introduction to smart polymers and their applications. In *Smart Polymers and Their Applications*, 1-11. <https://doi.org/10.1016/B978-0-08-102416-4.00001-6>
4. Aguilar, M. R., Elvira, C., Gallardo, A., Vázquez, B., & Román, J. S. (2007). Smart Polymers and Their Applications as Biomaterials. *Smart Polymers*, 3, 27.
5. Avinash Kumar Seth, Ghanshyam Parmar, Chintan Aundhia, Nirmal Shah & Dipti Gohil. (2024). Smart Polymer Systems: A Futuristic Approach to Enhance Therapeutic Efficacy. *Current Organic Chemistry*, 28(15), 1164-1178. <https://doi.org/10.2174/0113852728305580240429100851>
6. Bauri, K., Nandi, M., & De, P. (2018). Amino acid-derived stimuli-responsive polymers and their applications. *Polymer Chemistry*, 9, 1257-1287. <https://doi.org/10.1039/C7PY02014G>
7. Bahl, S., Nagar, H., Singh, I., & Sehgal, S. (2020). Smart materials types, properties and applications: A review. *Materials Today: Proceedings*, 28, 1302-1306.
8. Connal, L. A., Li, Q., Quinn, J. F., Tjipto, E., Caruso, F., & Qiao, G. G. (2008). pH-responsive Poly(acrylic acid) core cross-linked star polymers: Morphology transitions in solution and multilayer thin films. *Macromolecules*, 41(7), 2620-2626.
9. Chung, B. G., Lee, K. H., Khademhosseini, A., & Lee, S. H. (2012). Microfluidic fabrication of microengineered hydrogels and their application in tissue engineering. *Lab on a Chip*, 12(1), 45-59.
10. Dai, S., Ravi, P., & Tam, K. C. (2008). pH-Responsive polymers: synthesis, properties and applications. *Soft Matter* 4, 435. <https://doi.org/10.1039/b714741d>
11. Deepti Bharti, Indranil Banerjee, Preetam Sarkar, Doman Kim, & Kunal Pal. (2023). Smart polymers for biomedical applications. *Advances in Biomedical Polymers and Composites Materials and Applications*, 9, 223-246. <https://doi.org/10.1016/B978-0-323-88524-9.00010-3>
12. Fattah-alhosseini, A., Chaharmahali, R., Alizad, S., Kaseem, M., & Dikici, B. (2024). A review of smart polymeric materials: Recent developments and prospects for medicine applications. *Hybrid Advances*, 5, 100178. <https://doi.org/10.1016/j.hybadv.2024.100178>
13. Ganesh, V. A., Baji, A., & Ramakrishna, S. (2014). Smart functional polymers – A new route towards creating a sustainable environment. *RSC Advances*, 4, 53352-53364. <https://doi.org/10.1039/C4RA10631H>

14. Gohy, J. F., & Zhao, Y. (2013). Photo-responsive block copolymer micelles: Design and behavior. *Chemical Society Reviews*, 42(17), 7117.
15. Hung-Jin Huang, Yu-Liang Tsai, Shih-Ho Lin & Shan-hui Hsu. S. (2019). Smart polymers for cell therapy and precision medicine. *Journal of Biomedical Science*, 26, 73. <https://doi.org/10.1186/s12929-019-0571-4>
16. James, P. H., John, R., Alex, A., & Anoop, K. R. (2014). Smart polymers for the controlled delivery of drugs: A concise overview. *Acta Pharmaceutica Sinica B*, 4, 120–127. <https://doi.org/10.1016/j.apsb.2014.02.005>
17. Jochum, F. D., & Theato, P. (2013). Temperature- and light-responsive smart polymer materials. *Chemical Society Reviews*, 42(17), 7468-7483.
18. Kuhn, W., Hargitay, B., Katchalsky, A., & Eisenberg, H. (1950). Reversible dilation and contraction by changing the state of ionization of high-polymer acid networks. *Nature*, 165, 514-516. <https://doi.org/10.1038/165514a0>
19. Kim, J., Serpe, M. J., & Lyon, L. A. (2004). Hydrogel microparticles as dynamically tunable microlenses. *Journal of the American Chemical Society*, 126(31), 9512-9513.
20. Liu, F., & Urban, M. W. (2008). Dual temperature and pH responsiveness of poly (2-(N,N-dimethylaminoethyl methacrylate-co-N-butyl acrylate) colloidal dispersions and their films. *Macromolecules*, 41(17), 6531-6539.
21. Moses Kumi, Onome Ejeromedoghene, Wellington Dana Sudane, & Zexin Zhang. (2024, April 15). Unlocking the biological response of smart Stimuli-Responsive hydrogels and their application in biological systems. *European Polymer Journal*, 209, 112906. <https://doi.org/10.1016/j.eurpolymj.2024.112906>
22. Meng, H., & Li, G. (2013). A review of stimuli-responsive shape memory polymer composites. *Polymer*, 54(9), 2199-2221.
23. Nakayama, M., Okano, T., Miyazaki, T., Kohori, F., Sakai, K., & Yokoyama, M. (2006). Molecular design of biodegradable polymeric micelles for temperature-responsive drug release. *Journal of Controlled Release*, 115(1), 46-56.
24. Peng, K., Tomatsu, I., & Kros, A. (2011). Hydrogel-based drug carriers for controlled release of hydrophobic drugs and proteins. *Journal of Controlled Release*, 152, e72-e74.
25. Qiu, Y., & Park, K. (2001). Environment-sensitive hydrogels for drug delivery. *Advanced Drug Delivery Reviews*, 53(3), 321-339.
26. Riaz, R. S., Elsherif, M., Moreddu, R., Rashid, I., Hassan, M. U., Yetisen, A. K., & Butt, H. (2019). Anthocyanin-functionalized contact lens sensors for ocular pH monitoring. *ACS Omega*, 4(26), 21792-21798.
27. Shalla, A., & Bhat, M. (2021). Smart polymer composites in drug delivery. In *Smart Polymers Nanocomposites*, 261-294. <https://doi.org/10.1016/B978-0-12-819961-9.00009-8>
28. Wei, M., Gao, Y., Li, X., & Serpe, M. J. (2017). Stimuli-responsive polymers and their applications. *Polymer Chemistry*, 8, 127–143. <https://doi.org/10.1039/C6PY01585A>
29. Yang, H., Zhu, H., Hendrix, M. M. R. M., Lousberg, N. J. H. G. M., de With, G., Esteves, A. C. C., & Xin, J. H. (2013). Temperature-triggered collection and release of water from fogs by a sponge-like cotton fabric. *Advanced Materials*, 25, 1149-1152. <https://doi.org/10.1002/adma.201370052>
30. Zhuang, J., Gordon, M. R., Ventura, J., & Li, L., Thayumanavan, S. (2013). Multi-stimuli responsive macromolecules and their assemblies. *Chemical Society Reviews*, 42(17), 7421.
31. Zhang, Q., Lei, L., & Zhu, S. (2017). Gas-responsive polymers. *ACS Macro Letters*, 6(5), 515-522.
32. Zhao, Y., Lei, M., Liu, S. X., & Zhao, Q. (2018). Smart hydrogel-based optical fiber SPR sensor for pH measurements. *Sensors and Actuators B: Chemical*, 261, 226-232.
33. Bengi Ozkahraman. (2014). *Polimerik Hidrojel ve Mikrojellerin İlaç Salım Uygulamalarında Kullanımı* [Use of Polymeric Hydrogels and Microgels in Drug Delivery Applications]. T.C.İstanbul Üniversitesi, Fen Bilimleri Enstitüsü Doktora Tezi. Nisan.

34. Derya Mutlu & Idris Karagoz. Akıllı Malzeme Olarak Polimerler ve Uygulamaları [Polymers as Smart Materials and Their Applications]. *Konya Journal of Engineering Sciences*, 11(1), 274-299. <https://doi.org/10.36306/konjes.1106955>
35. Mutlu, D., & Karagöz, I. (2023). Akıllı malzeme olarak polimerler ve uygulamaları [Polymers as smart materials and their applications]. *Konya Journal of Engineering Sciences*, 11(1), 274-299. <https://doi.org/10.36306/konjes.1106955>
36. Tuylek, Z. (2019). Sağlık alanında kullanılan akıllı polimerler [Smart polymers used in healthcare]. *İnönü Üniversitesi Sağlık Hizmetleri Meslek Yüksek Okulu Dergisi*, 7(1), 81-95.

Received: 02.10.2024

Revised: 24.10.2024

Accepted: 14.11.2024

Published: 20.12.2024

<https://doi.org/10.36719/2707-1146/51/27-34>

**Novruz Shiraliyev**

Water and Amelioration Scientific Research Institute PLE  
novruzs@gmail.com  
<https://orcid.org/0009-0006-4189-462X>

**Banovsha Mehdiyeva**

Water and Amelioration Scientific Research Institute PLE  
Doctor of Philosophy in Technical Sciences  
banovsha-64@mail.ru  
<https://orcid.org/0000-0001-6867-7198>

**Asmar Abbasova**

Water and Amelioration Scientific Research Institute PLE  
esmer\_sq@mail.ru  
<https://orcid.org/0009-0009-4047-5127>

**Narmina Iskandarova**

Water and Amelioration Scientific Research Institute PLE  
nrmin.sgndrova@mail.ru  
<https://orcid.org/0009-0002-6374-2338>

## **Protection of Underground Parts of a Multi-Storey Building from the Negative Impact of Groundwater Using Jet Grouting Technology**

### **Abstract**

Protecting part of the zero cycles of multi-storey residential buildings built in areas with a complex geological structure and dense urban development from the negative effects of groundwater is one of the most important problems arising in modern urban planning.

Although the specified groundwater level during engineering and geological surveys is considered when designing multi-story buildings, in many cases, the possibility of groundwater level changes due to natural-technogenic, physical-geological, physical-geographical, and anthropogenic factors is not considered. Therefore, after the buildings are constructed and put into operation, the parts of the building located below the zero level (car garage, basement, etc.) are exposed to the negative effects of groundwater. In addition to the discomfort caused by groundwater penetrating the foundations and other structural elements of multi-story buildings, depending on the degree of aggressiveness of these waters, they also cause wear and corrosion of reinforced concrete structural elements and generally reduce the service life of the building. The development of engineering protection measures to eliminate the aforementioned problems, prevent the causes of these problems, or minimize the negative impacts arising from these problems has become a necessary component of the construction process due to its relevance.

The main objective of this article is to protect the zero-cycle structural elements of multi-story buildings from the negative impact of groundwater by using Jet Grouting technologies to prevent the aforementioned negative phenomena. The article is based on the results of real research and actual work performed.

**Keywords:** *multi-storey building, groundwater, soil-concrete column, Jet Grouting, foundation, underground part, protection*

### **Introduction**

As in all developed and developing countries, in the Republic of Azerbaijan, due to the increase in population, acceleration and expansion of civil, industrial and infrastructure construction works (Shiraliyev et al., 2024), the location of large industrial enterprises and business centers in the country's central and large cities, and other factors, construction and installation work such as the rapid development of urban planning activities, the construction of new multi-storey residential buildings, the demolition and reconstruction or restoration of old buildings, and the creation of green spaces, parks, and recreational areas have become widespread.

Cities around the world are significantly expanding in terms of size and population, potentially resulting in more than two billion additional urban residents by 2030. To date, around 54 % of the global population lives in cities, and this fraction is expected to rise to 60 % - 92 % till the end of the 21st century (Jing et al., 2023; Connor, 2015; Jiang et al., 2017).

Due to the above factors, the design and construction of multi-story residential buildings with deep foundations have accelerated significantly in the cities of Baku and Sumgait, which are located on the Absheron Peninsula, which has a complex geological structure and hydrogeological conditions.

High-rise apartment buildings, which house a significant proportion of the urban population, constitute an important part of the housing stock in many cities around the world (Nguyen et al., 2024; Dang, 2021; Yuen et al., 2006).

Currently, the most intensive construction, restoration, and reconstruction work on housing construction in Baku is carried out mainly in the central parts of the city, and by the distinctive feature of modern urban development, special attention is paid to the maximum and effective use of underground spaces of the construction site.

The most intensive construction work related to the construction of multi-story residential buildings is carried out in the central part of the city. In many cases, these buildings are built near each other in dense urban development conditions and have deep foundations.

Incorrect assessment of hydrogeological conditions during the design of buildings, the negative impact of the foundations of buildings built close to each other on the natural regime of groundwater, and changes in the physical and chemical properties of water lead to the emergence of certain problems during the operation of buildings and a reduction in the service life of buildings.

Groundwater, which is a weak solution of chemicals, at a certain concentration forms an environment that is aggressive towards the materials of underground structures.

At a high level of groundwater, the territory is flooded, which causes, to a certain extent, difficulties in the construction and operation of buildings and structures (Kurmanov et al., 2017).

After the construction and commissioning of the building under study, under the influence of various factors, the engineering and geological conditions of the construction site changed, the groundwater level increased, as a result of which the underground part of the building was flooded, and the structural elements of the underground part of the building were subjected to weak aggression from soil and water.

It was considered necessary to implement measures to protect the underground part of multi-story buildings to prevent the above-mentioned negative situations, protect building structures from the negative effects of groundwater, ensure the stability of the building, and prevent flooding.

### Research

Research works were carried out in the location of a 9-story building located in the central part of Baku city (Fig. 1).

**Figure 1** Research area. Baku city, Narimanov district



The geological structure of the research area at a depth of up to 25 meters includes deposits of the Holocene and Pleistocene stages of the Quaternary system.

Technogenic deposits were found in depth intervals of the geological structure of 0.0-1.9 meters and, according to their lithological composition, consisting of clay, loam and various types of plant remains.

The deposits of the Caspian tier consist of clays with gravel fragments and sand layers, medium- and fine-grained sand with clay and sandstone layers, clay layers with sandstone layers and were formed in the geological structure in the depth range of 1.9-19.8 meters.

The deposits of the Baku stage of the Pleistocene consist of semi-hard clay rocks, formed in the deepest part of the research area and were found in the depth range of 19.8-25.0 meters.

The groundwater level is 4.5 m.

Based on statistical processing of laboratory analysis results, 4 Engineering-geological (EGE) elements were identified (Fig. 2):

EGE-1. Loam, hard,  $W=16.5$ ,  $P=2.0$  g/sm<sup>3</sup>,  $P_d=1.73$  g/sm<sup>3</sup>,  $e=0.572$ ,  $S_r=0.77$ ,  $W_L=29.8$ ,  $W_p=18.5$ ,  $I_p=11.3$ ,  $I_L<0$ ,  $C=0.36$  kg/sm<sup>2</sup>,  $tg\phi=0.466$ ,  $E=32.8$  MPa.

EGE-2. Medium-grained sands,  $W=8.0(26.0)$ ,  $P=1.75$  g/sm<sup>3</sup>,  $e=0.569$ ,  $S_r=0.37(0.87)$ ,  $\phi=34^0$ ,  $E=12.0(35.0)$  MPa.

EGE-3. Hard plastic clay,  $W=23,5$ ,  $P=2.02$  g/sm<sup>3</sup>,  $P_d=1.64$  g/sm<sup>3</sup>,  $e=0.671$ ,  $S_r=0.96$ ,  $W_L=36.6$ ,  $W_p=17.2$ ,  $I_p=19.4$ ,  $I_L=0,3$ ,  $C=0.54$  kg/sm<sup>2</sup>,  $tg\phi=0.315$ ,  $E=19.5$  MPa.

EGE-4. Semi-hard clay,  $W=20,7$ ,  $P=2.0$  g/sm<sup>3</sup>,  $P_d=1.66$  g/sm<sup>3</sup>,  $e=0.654$ ,  $S_r=0.86$ ,  $W_L=37.7$ ,  $W_p=18.7$ ,  $I_p=19$ ,  $I_L=0,11$ ,  $C=0.68$  kg/sm<sup>2</sup>,  $tg\phi=0.364$ ,  $E=24.0$  MPa.

**Figure 2** Engineering-geological model of the building's soil foundation

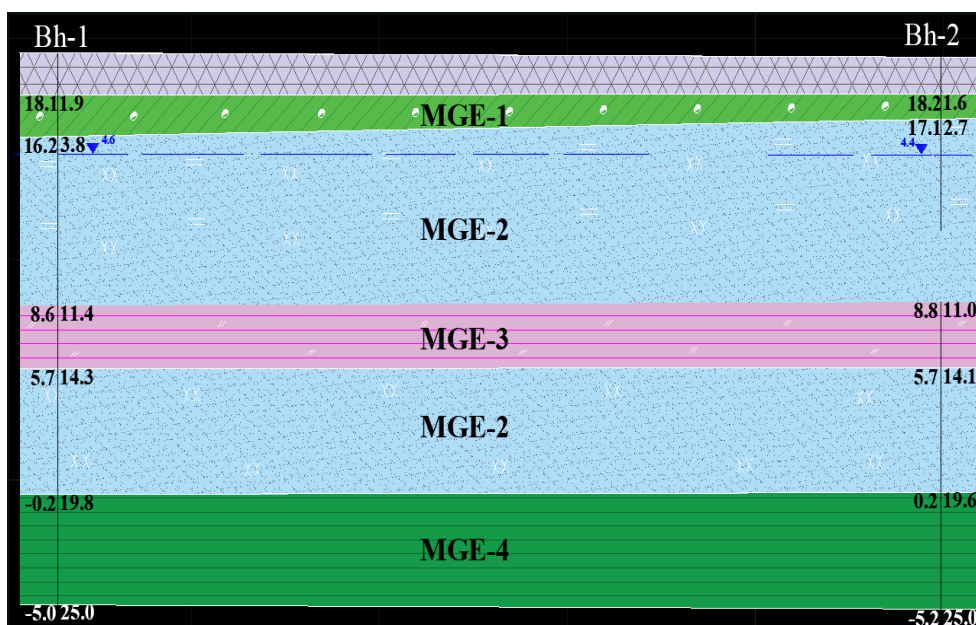

Taking into account the physical and mechanical properties of the soil, the depth of groundwater, and the negative impact of groundwater on the building structures located in the zero cycle, it was decided to develop measures to protect the underground parts of the building from the impact of groundwater using Jet Grouting technology.

Jet grouting is the youngest major category of grouting for ground treatment. The ASCE Geotechnical Engineering Division Committee on Grouting (1980) defined jet grouting as a "technique utilizing a special drill bit with horizontal and vertical high-speed water jets to excavate alluvial soils and produce hard impervious columns by pumping grout through the horizontal nozzles that jets and mixes with foundation material as the drill is withdrawn". The jet grout execution is schematized in Figure 3 (Guler et al., 2021).

Figure 3 Jet grout column execution

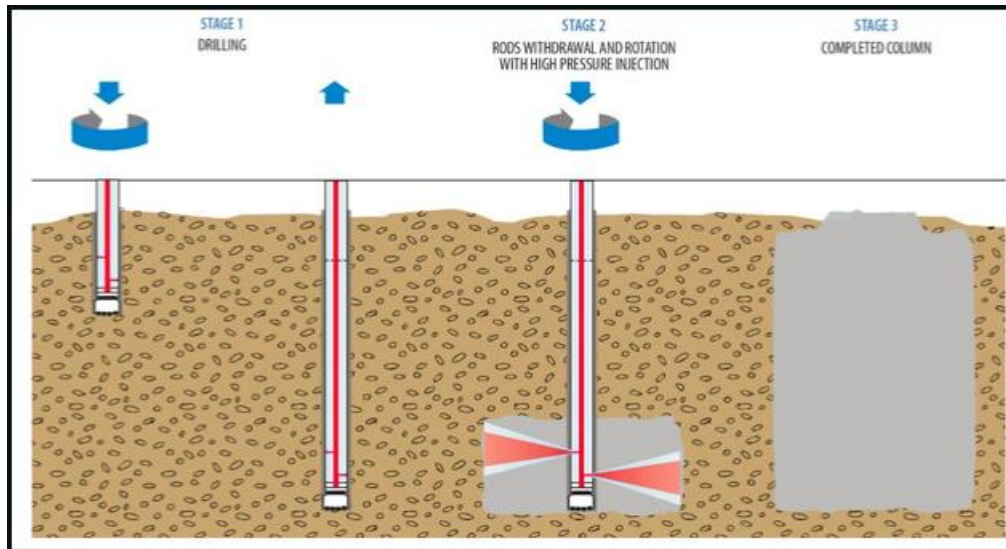

Soil concrete columns installed using Jet Grouting technology, which is used to prevent groundwater from entering the building's soil foundation and to increase the strength of wet sands, perform two important functions:

1. Accepts part of the pressure created by the mass of the building and transfers it to the more reliable soil at the base of the soil-concrete column;
2. It serves as the most reliable waterproofing device, preventing liquefaction processes from suffusion and seismic impacts, and also protecting the underground part of the building from groundwater penetration;

Jet grouting techniques are frequently adopted to ensure the stability and waterproofing required for constructing high-risk and challenging underground infrastructures. Over the past decades, significant progress has been made in Jet Grouting technology, especially in quality control and quality assurance methods for jet-grouted columns (e.g., drilling alignment, diameter inspection/monitoring, and strength control of jet-grouted columns). It has made jet grouting easier and less expensive to implement. Also, the bearing capacity and the waterproofing performance of the jet-grouted columns are significantly improved (Cheng et al., 2023).

Taking into account the soil conditions of the foundation base, a single-component technology (Jet-1) was used when forming the soil-concrete column using Jet Grouting technology. With single-component cementation under pressure, the soil was washed and mixed with cement mortar only by jet cementation.

When using a single-component technology (Jet-1), under a jet of cement mortar with a pressure of 400-600 atmospheres, the soil is destroyed and then mixed with the mortar, resulting in the formation of a soil-concrete column with a diameter of 0.6-1.2 meters. This technology is simple, since a minimum set of equipment is used (Zhadanovsky et al., 2024).

The main parameters accepted during soil processing for the creation of a soil-concrete column using Jet Grouting technology: cement mortar injection pressure – 35-40 MPa, productivity of the introduced cement mortar – 120 liters/minute, number of nozzles – 2 pieces, nozzle diameter 3.2 mm, height of cyclic monitor lift – 4 cm, drilling column lift speed – 30 cm/min, monitor rotation speed – 10 rpm, cement-sand mortar ratio –  $W/S = 1.0$ , nozzle rotation –  $360^\circ$ .

To calculate the technological indicators, the frequently used cyclic mode of the device of a soil-concrete column with a diameter of  $D$  (Fig. 4) is considered when in each cycle the monitor is raised by the value of the step  $S$ . The step value is determined empirically from the point of view of achieving high homogeneity of the soil and in practice is  $S = 4...10$  cm. After processing the soil during the time interval, the monitor is further raised by step  $S$ , etc. (Malinin, 2003).

**Figure 4** Scheme of formation of a soil-concrete column

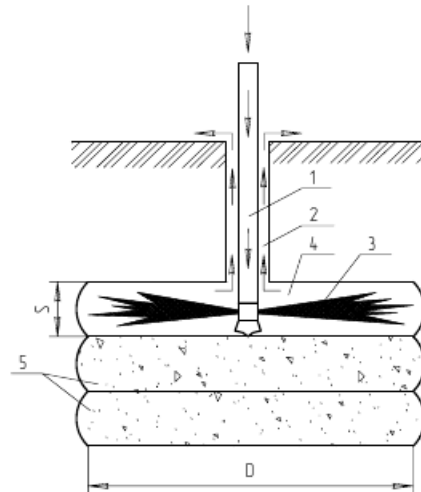

1. Cement slurry inlet.
2. Pulp outlet through the annulus.
3. Water-cement jet.
4. Volume of soil being processed.
5. Soil processed during previous cycles.

While carrying out work on protective measures against the negative effects of groundwater using the Jet Grouting method, the technological sequence of installing soil-concrete columns in various areas of the foundation perimeter (Fig. 5) was followed.

**Figure 5** Scheme of application of Jet Grouting technology for protection of underground part of the building from groundwater

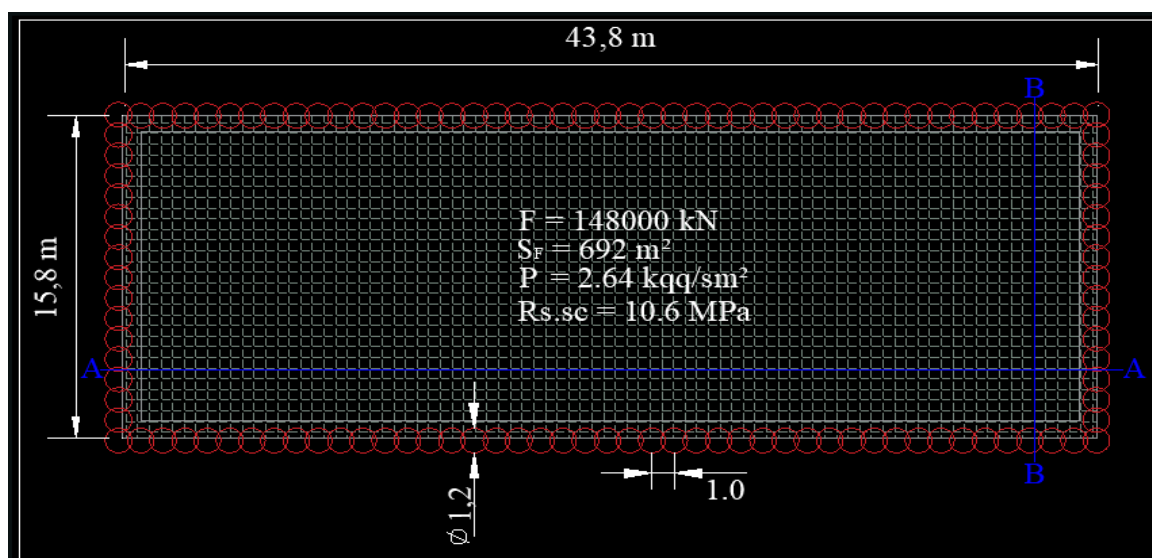

The strength of the soil-concrete column resulting from the processing of the soil with the single-component Jet Grouting technology depends on the properties of the soil and also on the amount of cement used to wash and mix the soil.

In this regard, the amount of cement to be used to prepare the soil-concrete column according to the required parameters must be determined.

**The cement consumption required for soil treatment in one cycle (S=4 cm) was calculated as follows:**

The density of the solution at a water-cement ratio  $w_c$  will be



$$P_{wc} = (1 + wc) / (1/P_c + wc/P_w) = 1.46 \text{ g/sm}^3$$

Where  $P_c$ ,  $P_w$  are the density of cement and water particles, respectively.

The volume of soil processed during one cycle

$$V_s = \frac{\pi D^2}{4} S = 0.045 \text{ m}^3$$

The volume and mass of cement slurry entering the well during the time interval

$$\Delta V_1 = q * \Delta t_1 = 8 \text{ L} = 0.008 \text{ m}^3$$

$$m_{wc} = P_{wc} * \Delta V_1 = 1.46 * 0.008 = 11.68 \text{ kg}$$

Determination of cement consumption  $q_c$  and water  $q_w$

$$q_c = 1 / (1/P_c + wc/P_w) * q = 87.6 \text{ kg}$$

$$q_w = wc / (1/P_c + wc/P_w) * q = 87.6 \text{ kg}$$

The entry of cement and water into the soil in mass terms

$$m_c = q_c * \Delta t_1 = 5.8 \text{ kg} \quad m_w = q_w * \Delta t_1 = 5.8 \text{ kg}$$

Determination of the mass of soil and water contained in the volume  $V_s$

$$m_g = (1 - P_0) * P_g * V_s = 144.7 \text{ kg}$$

$$m_w = P_0 * P_w * V_s = 36.0 \text{ kg}$$

The amount of cement, soil, and water remaining in the soil-concrete column in the first stage,

$$m_c = q_c * \Delta t_1 * \theta_1 = 5.0 \text{ kg}$$

$$m_g = (1 - P_0) * P_g * V_s * \theta_1 = 61.5 \text{ kg}$$

$$m_w = (q_w * \Delta t_1 + P_0 * P_w * V_s) * \theta_1 = 5.0 \text{ kg}$$

The amount of cement, soil and water remaining in the soil-concrete column in the second stage,

$$m_c = (q_s * \Delta t_1 * \theta_1 + q_c * \Delta t_2) * \theta_2 = 9.2 \text{ kg}$$

$$m_g = (1 - P_0) * P_g * V_s * \theta_1 * \theta_2 = 52.3 \text{ kg}$$

$$m_w = [ (q_w * \Delta t_1 + P_0 * P_w * V_s) * \theta_1 + q_w * \Delta t_2 ] * \theta_2 = 9.2 \text{ kg}$$

The soil-concrete column, constructed using the Jet Grouting method, has the following main properties: the column cementation period is 200 seconds, and the amount of cement in 1 m<sup>3</sup> is 403.0 kg.

The installation of soil-concrete columns was carried out in two stages;

I – A borehole with a diameter of 90 mm was drilled to the design depth by introducing a monitor;

II – Simultaneously with the cutting and dispersion of the soil, the cement mortar pumped into the borehole under pressure was intensively mixed with the cut and crushed soils, resulting in the formation of a homogeneous soil-concrete column with a density of 1.4-1.9 t/m<sup>3</sup>.

Considering the non-aggressive nature of groundwater about concrete structures, cement grade PC 500 was used in the manufacture of soil-concrete columns. It is possible to use cement-grade PC 400 with the addition of a plasticizer.

Taking into account the inclination of the soil layers that form the geological environment, the direction of groundwater flow, the porosity of medium and fine-grained sands saturated with water, and other factors, the sequence of creating the soil-concrete columns to be installed in the underground part of the building was chosen in such a way that a decrease in the groundwater level in the building's foundation was observed under the sequence of the work process.

When implementing the Jet Grouting technology to protect the underground part of the building from the negative impact of groundwater, a small-sized Keller (AFR) SC-1 device was used. The compressive strength of the installed soil-concrete columns along the perimeter of the building foundation (Fig. 6 and Fig. 7) was 10.6-14.4 MPa (SP, 2017).

**Figure 6** Construction of soil-concrete columns using Jet Grouting technology. The section along line A-A

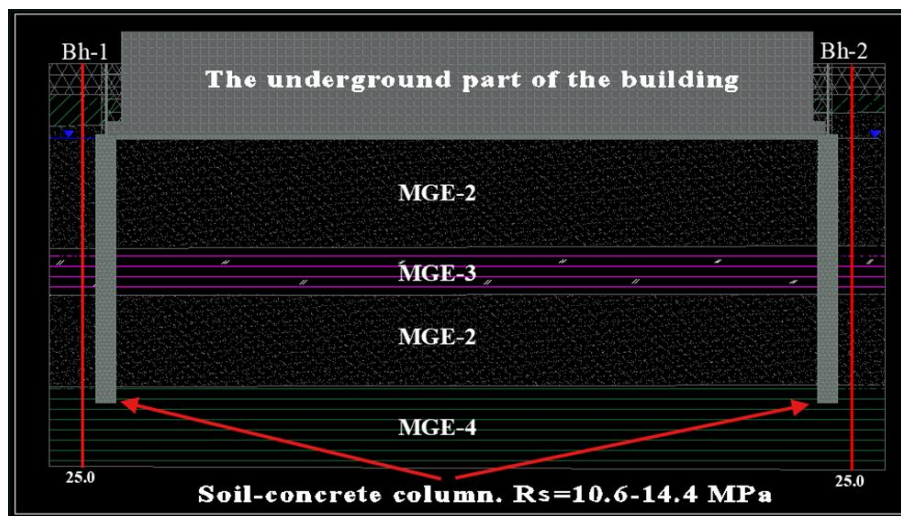

**Figure 7** Construction of soil-concrete columns using Jet Grouting technology. The section along line B-B

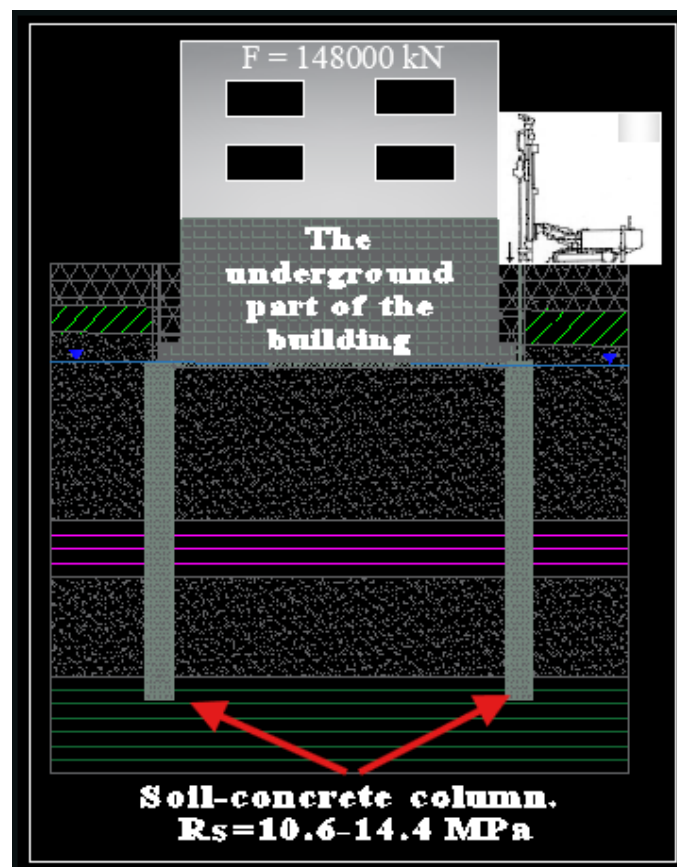

### Conclusion

Based on the engineering protection measures implemented using Jet Grouting technology, the following results were achieved:

- The ingress of groundwater into the soil mass of the building foundation and the negative impact of groundwater on the structural elements of the building in the zero cycles were completely prevented, and closer to the end of the work on the construction of soil-concrete columns, the groundwater level dropped to a depth of 17-18.0 meters

- As a result of the decrease in humidity, and increase in the density and resistance force of wet sands, which are the main soil in the geological structure of the building construction site, the seismic properties of the soils that make up the geological environment decreased from 9 points to 8 points;
- The process of liquefaction of water-saturated sands in the foundation of the building was completely prevented;
- The level of risk to the safe operation of the building was minimized and the safe operation of structural elements in the underground part was restored.

### References

1. Connor, R. (2015). *The United Nations World Water Development Report 2015: Water for a Sustainable World*. UNESCO Publishing.
2. Cheng, Sh., Chao, K., Wong, R., & Morris I-Min Wang, M. I. (2023). Control of jet grouting process induced ground displacement in clayey soil. *Transportation Geotechnics*, 40, 100983. <https://doi.org/10.1016/j.trgeo.2023.100983>
3. Dang, T. (2021). Spatial distribution of high-rise buildings in Hanoi city inner. *International Journal of Advanced Research in Engineering and Technology*, 636–643. <https://doi.org/10.34218/IJARET.12.3.2021>
4. Guler, E., & Gumus Secilen, G. (2021). Jet grouting technique and strength properties of jet grout columns. *Journal of Physics: Conference Series*, 1928012006. <https://iopscience.iop.org/article/10.1088/1742-6596/1928/1/012006>
5. Jing, M., Pujades, E., Liu, J., Jurado, A., & Lu, Ch. (2023). Effect of underground structures on groundwater residence time distributions in confined aquifers. *Journal of Hydrology*, 624, 129938. <https://doi.org/10.1016/j.jhydrol.2023.129938>
6. Kurmanov, A. K., & Askarov, D. A. (2017). Influence of groundwater level during construction and reconstruction of buildings and structures. *Science and Technology of Kazakhstan*, UDC 624.131.6
7. Leiwen Jiang, & Brian, C. O'Neill. (2017). Global Urbanization Projections for the Shared Socioeconomic Pathways. *Global Environmental Change*, 42, 193-199.
8. Malinin, A. G. (2003). Justification of cement consumption in jet grouting of soil. *Appendix to Underground space of the world "Problems of development of transport structures and engineering communications*, 2-3.
9. Nguyen, L. P., Paulin, E. V., Kemperman, A., & Mohammadi, M. (2024). Social impacts of living in high-rise apartment buildings: The effects of buildings and neighborhoods. *Journal of Urban Affairs*. <https://doi.org/10.1080/07352166.2024.2311165>
10. Shiraliyev, N., Khalilova, A., & Abbasova, A. (2024). Geotechnical Justification for Designing Landslide Prevention Measures. *Nature & Science*, 6(10). <https://doi.org/10.36719/2707-1146/49/28-38>
11. SP. (2017). SP 291.1325800. *Soil-cement structures. Reinforced. Design rules*. Standartinform.
12. Yuen, B., Yeh, A., Appold, S. J., Earl, G., Ting, J., & Kwee, L. K. (2006). High-rise Living in Singapore Public Housing. *Sage Journals*, 43(3), 583-600. <https://doi.org/10.1080/00420980500533133>
13. Zhadanovsky, B. V., Graneva, A. V., & Abramova, S. V. (2024) Modern Possibilities of Jet Grouting of Soils. *Engineering Bulletin of the Don*, 1. <http://ivdon.ru/ru/magazine/archive/n1y2024/8919>

Received: 08.10.2024

Revised: 30.10.2024

Accepted: 09.11.2024

Published: 20.12.2024

<https://doi.org/10.36719/2707-1146/51/35-38>

**Ilgar Ibrahimov**

Nakhchivan Scientific Research Institute named after Academician H. Aliyev  
ilqaribrahimov975@gmail.com  
<https://orcid.org/0009-0007-8285-2758>

**Mahira Fatullayeva**

Nakhchivan Scientific Research Institute named after Academician H. Aliyev  
mfetullayevaa@gmail.com  
<https://orcid.org/0009-0002-0452-0639>

## **To Study the Botanical Characteristics of the Plant, its Resistance to Stress Factors (Biotic, Abiotic) in Order to Preserve the Gene Pool of Local and Introduced Barley and Wheat Varieties in Soil-Climatic Conditions of the Nakhchivan Autonomous Republic**

### **Abstract**

The main goal of the study is to study the ecological origin, lifestyle, species diversity of wheat and barley samples, which are of strategic importance, ensuring the economic security of the country, forming the main and irreplaceable food of people. In the soil-climatic conditions of the Nakhchivan Autonomous Republic, intensive technology elements (fertilizing, soil cultivation, selection of varieties, sowing period, sowing method, sowing norm, irrigation methods and duration, plant protection) are applied both individually and in a complex manner. Biological characteristics, assessment, their comparative characteristic and continuous study of high-quality and productive varieties of wheat and barley, suitable for local soil and climatic conditions, resistant to unfavorable factors of the external environment.

**Keywords:** *research, yield, sowing rate, grain production, varieties, stress factors*

### **Introduction**

Grain crops are of great importance for providing the population with food, livestock with feed and industry with raw materials. Therefore, increasing grain production both in the world and in our republic is one of the most important problems for modern times. In this regard, in order to meet the needs of the population in food, the volume of grain production should be increased and its quality improved. It is very important to constantly carry out appropriate measures to fully meet the needs of the population in food products. In order to fully meet the needs of the population in our Republic, at the expense of our own production, it is necessary to increase the productivity in grain production. Therefore, in increasing the production of grain, first of all, it is extremely important to create new high-yielding, dormancy, disease and pest, drought and frost-resistant, high-quality varieties and to cultivate them in the necessary agrotechnical manner by applying them to farms.

### **Research**

Research works were carried out in the direction of “study of botanical characteristics of plants, resistance to stress factors (biotic, abiotic) for preservation of gene pool of local and introduced barley and wheat varieties in soil-climatic conditions of Nakhchivan Autonomous Republic” on theoretical and application issues of genetics, selection, seed production and Agrotechnology of plants for the development of Agrarian science, as well The trial experiments, the study of which was carried out by Academician H. Aliyev. It was carried out in the field of practice of Nakhchivan Scientific Research Institute named after Aliyev on irrigated Gray lands, in irrigation conditions. As research material, varietal samples of 8 barley, 9 durum wheat and 41 soft wheat crops were taken.

Local barley, durum wheat, soft wheat samples included in the study were obtained mainly from Azerbaijan ETASI, tartar BTB, Gobustan BTS, Jalilabad BB, Absheron BTS experimental stations and began to be studied in soil-climatic conditions of Nakhchivan Autonomous Republic.

In accordance with the methodology, phenological observations and biometric measurements were carried out on all varieties separately, structural and qualitative analyzes of the studied varietal

samples were studied. The vegetation period of the research experiments was 245-255 days, of which 75 days fell on the day of plant growth (Hamidov, 2008, p. 20).

Each variety of the samples was evaluated with 5 points of dormancy, 5 points of frost and drought resistance, 9 points of disease resistance. In alternating plantings, it is necessary to take into account the placement of winter wheat after better predecessors, ensuring a weakly acidic and neutral reaction of the soil environment, timely implementation of agrotechnical measures. According to the results of our scientific research, the best predecessor plants for winter wheat in soil-climatic conditions of Nakhchivan Autonomous Republic are perennial grasses corn and legumes. After such predecessors, the site must be plowed to a depth of 25-30 cm.

As a result of the research, on October 20, 2023, the arable land was plowed to a depth of 25-30 cm and collected. According to the scheme drawn up on October 21-22, 2023, experimental spots were developed in dimensions of 66 pieces of 2 m<sup>2</sup> da (2 x 1). Each prepared lakh was divided into 6 rows, the distance between the rows was 16.5 cm. The distance between each spots was 50 cm, the distance between the stripes was 100 cm. (Dospekhov, 1985, pp. 6-7).

According to the indicators of our research, one of the most important agrotechnical measures for obtaining high yields of winter wheat and barley crops is the correct determination of the sowing period. The optimal sowing period for the lowland zone of the Autonomous Republic is the third decade of October. The sowing rate depends mainly on the purity of the seed, the percentage of germination, the mass of 1000 grains, the duration and method of sowing, the provision of soil with nutrients, the biological characteristics of the variety, etc. depends.

On October 25, 2023, seed varieties were treated with Rubin 2 DS fungicide to make them resistant to pre-sowing diseases and each 2 m<sup>2</sup> (1 x 2) sized spots were sown with 50 grams of barley and 60 grams of wheat seeds. Experimental test plantings were carried out in the size of 2 m<sup>2</sup> (2 x 1), in 2 repetitions 8 barley varieties in 32 m<sup>2</sup>, in 1 repetition 9 durum wheat varieties in 18 m<sup>2</sup>, in 1 repetition 41 soft wheat varieties in 82 m<sup>2</sup>. Total: on 132 m<sup>2</sup>, experimental plantings of 50 varieties of wheat and 8 varieties of barley were carried out. After sowing, the experimental spots are watered (Dospekhov, 1985, pp. 10-11).

One of the most important measures in the cultivation of winter wheat and barley crops on the basis of intensive technologies is the application of fertilizers. From winter wheat high and to obtain a quality product, fertilization must be correctly determined depending on the ratio of NPK to each other, soil-climatic conditions, predecessors, the degree of soil supply with fertilizers and the biological nature of the variety. So, at the expense of the active substance, potassium should be given under the Plow by 60 kg, phosphorus-by 90 kg. At the expense of the active substance, nitrogen should be supplied under 20 kg of plowing, and 40 kg in the form of two feeding in the spring.

In 2024, in the third decade of April, nitrogen fertilizer was introduced as a feeding norm of 2 grams per 2 M80 spots.

Irrigation works in the Autonomous Republic are carried out by furrow method. During such irrigation, both water is saved and the site is evenly moistened. Timely and high-quality plant irrigation contributes to high yields. In the conditions of the Autonomous Republic, it is important to provide grain with 3 vegetable waters. Growing water should be given during periods when the grain has a greater demand for water. This demand is greater in the phases of the end of the Bush, the beginning of the exit to the pipe, hyacinth and grain filling.

In the course of our research, in April 2024, experimental spots were given the first growing water in early spring, the second growing water was carried out in the pipe exit phase of the grain (in the second decade of may), and the third watering was carried out in the spike and grain filling phase (in the second decade of June).

In the experimental testing area where the research was carried out, from the 3rd ten days of December 2023, until the 3rd ten days of March, phenological observations were started after the plants completed their calm period. An observation Journal has been developed for the registration of phenological observations. As a result of phenological observations of wheat and apa plants, biometric measurements were carried out in the direction of plant development, it was found that

the height of plants is on average 95-100 cm, the development of the root system of plants is 20-25 cm, the formation of 8-12 hyacinths from each grain was observed. The plant was examined under a microscope on plant samples brought from the experimental field in the conditions of laboratory for the study of diseases and pests, which were in the phase of hyacinth formation (pollination phase). Consequently, no diseases or pests were observed in the plants (Gurbanov, 2017, pp. 15-16).

On May 03-10, 2024, in accordance with the individual work plan, many processes taking place in the direction of the development of plants on each variety in the experimental trial area phenological observation studies have been continued to determine.

On May 10, 2024, as a result of phenological observations carried out at the experimental test site, plants were observed to be in the tube exit phase. The plant was not affected by biotic, abiotic factors. On average, the height of the plants was 100-105 cm, the length of the spike was 10 cm. On May 20, 2024, phenological observation work was continued at the experimental trial planting site (Musayev, 2008, p. 88).

It was found that as a result of rains in May 2024, hyacinths were not broken, bushes were crushed and bushes were not lying in the experimental field as a result of regular rains in May 2024, excessive growth of weeds was observed in the experimental field.

To obtain a high yield of grain crops, weed control measures must be carried out. If the control measures are carried out correctly, the yield is 3-5 sen, the amount of gluten in the grain is 2.0-2.5 %, and the protein content is 0.5-1.0 %.

In the conditions of the Autonomous Republic, wild radish, sow thistle, field Buttercup, Compass milking and others are more common in winter grain fields. For chemical control, Hectaferrin should be applied at a rate of 2 liters/ha with a working solution of 300 liters, when the height of the weed is 10-12 cm, or by spraying until the period of tubular extraction of the grain (Aghayev, 2017, p. 43).

In the third decade of May in 2024, work was carried out on the intermediate distances of the experiment and cleaning of the surrounding areas from weeds, chemical control measures were carried out with the consumption of 2 liters of working solution per 300 liters of Hectaferrin per liter/ha.

Before harvesting, plants and hyacinths on plants in 2 m<sup>2</sup> (2 x 1) spots were counted and recorded in the field journal. In order to avoid grain loss, harvesting should be completed as soon as possible and without loss in dry weather, when the grain of the grain has a moisture content of 16-17 %.

In the third decade of June in 2024, barley and wheat varieties were harvested at the experimental test site and tied in the form of tails by varieties separately. Harvesting was done manually. From the tails we picked up on June 24-25-26, 2024, the final results of the test experiments we carried out by weighing the product and converting it to hectares were determined.

In 2024, in the first decade of June, the tails harvested from the experimental test site were beaten with molotilka and packed in bags by varieties separately (Dorofeyev, 1977, p. 27).

### Conclusion

The final results of the experiments carried out by the tails taken from the experimental test site, the length of hyacinth, mass of grain in Hyacinth, number of grain in Hyacinth, mass of 1000 grains, weighing of the crop and converting it to hectares were determined by the following indicators: study of botanical characteristics of plant for preservation of local and introduced wheat.

The productivity of varietal samples was between 25 sen and 93 sen.

#### Low yield barley varieties

Karabakh – 33 48 sen  
Karabakh – 32 24,7  
Buta – 84 sen  
Karabakh – 22 93 Sep  
Jamil – 67,8 sen

#### Upper yield barley varieties

Garagilchigli – 93 sen  
Sep Ugur – 88 Sep

**Low yield durum wheat varieties**

Tartar Kahraba – 47,5  
Precious 2 – 17 47 sen  
Zangezur – 74,7 sen

**Upper yield durum wheat varieties**

Sen Parzivan – 1 92 sen  
Alinja – 78,5 sen,

**Low productivity soft wheat varieties**

Sunny – 32 sen  
Sanzor-Gobustan – 44 sen  
White – 97,5  
Sustenance – 84 93,2

**Upper yield soft wheat varieties**

Dignified – 93 sen  
Mirbashir – 72 sen

Research and experimental works of wheat and barley varieties samples in field conditions the study of their characteristics, the main issues and directions of varietal and seed control, varietal control – the methods of field approbation and its implementation, pre-harvest assessment of grain fields, importance of the variety in agriculture, their types, species diversity and varieties, observation and experimental methods in Variety control, seed control, methods for determining seed quality indicators, biochemical and aerodynamic characteristics of seeds, damage to seeds during beating, methods for classifying and determining damage were carried out (Dospekhov, 1985, pp. 17-19).

**References**

1. Aghayev, C. T. (2017). *Pests and weeds of grain crops*.
2. Dospekhov, V. A. (1985). *Methodology of field experiment*. Agropromizdat.
3. Dorofeyev, V. F. (1977). *Methodological guidelines for studying the world collection of wheat*. L.VIR.
4. Gurbanov, F. (2017). *Variety and seed control*.
5. Hamidov, H. N. (2008). *Physiological characteristics of new high-yielding wheat varieties in different environmental conditions*. Biol. Science. Abstract of the candidate's dissertation.
6. Musayev, A. C., Huseynov, H. S., & Mammadov, Z. A. (2008). *Methodology of field experiments on research work in the field of selection of cereal grain crops*.

Received: 03.10.2024

Revised: 26.10.2024

Accepted: 15.11.2024

Published: 20.12.2024

<https://doi.org/10.36719/2707-1146/51/39-46>

**Vafa Ramazanli**

Baku State University

Ph. D. student

[vefa\\_ramazanli@hotmail.com](mailto:vefa_ramazanli@hotmail.com)

<https://orcid.org/0009-0003-9687-5169>

**Ulviyya Karimli**

Garabagh University

[karimli@mail.ru](mailto:karimli@mail.ru)

<https://orcid.org/0009-0001-5290-7160>

## Evaluation of the Antioxidant Activity of Rosa canina Plant Fruit

### Abstract

Three types of Rosa canina plant extracts were prepared. The antioxidant activity of the first prepared solution was measured using a UV spectrophotometer in the bioengineering laboratory. The resulting graph shows that the DPPH free radical is blocked by the antiradical antioxidant contained in the rosehip plant extract. We then analyzed the resulting graph using Origin Corporation software and obtained a new graph. Origin Corporation software offers a wide range of features, making it easy to analyze the laboratory results. The software analyzes the results by performing mathematical calculations and provides more detailed information. These analyses allow for the evaluation of the potential antioxidant properties of the Rosa canina plant and enhance the understanding of its potential use in medical fields. The findings could contribute to the future application of rosehip in therapeutic practices and health-related research.

**Keywords:** *Rosa*, plant extract preparation, antioxidant activity, UV spectrophotometry, Antiradical antioxidant

### Introduction

In recent years, the health benefits of plants, particularly their antioxidant activities, have been extensively studied. Rosa canina (dog rose) is known for its rich content of vitamins, minerals, and bioactive compounds. The extracts of this plant are especially significant for their antiradical properties, which can play a key role in combating free radicals. Free radicals are responsible for a range of diseases, including cancer, cardiovascular diseases, and aging. Therefore, the study of antioxidant compounds derived from plants is crucial for health preservation and disease prevention. In this study, the antioxidant activity of extracts from Rosa canina fruits was evaluated using various methods. Two different types of extracts were prepared, and their antioxidant properties were measured using a UV spectrophotometry device. The results demonstrated that the dog rose extract effectively blocks DPPH free radicals. Additionally, the analysis of the resulting graphs was performed using Origin Corporation software, which facilitated the interpretation of the data through mathematical calculations. This tool allows for more efficient and precise analysis of laboratory results.

The aim of this study is to measure the antioxidant potential of Rosa canina extracts and identify how this activity changes across different preparation stages. The findings could further highlight the health benefits of this plant and contribute to its wider application in the medical field.

The growing interest in natural antioxidants has led to an increasing number of studies focusing on plant-based compounds as potential alternatives to synthetic antioxidants. Rosa canina, with its rich biochemical composition, presents itself as a valuable source of natural antioxidants. Its fruit is known for high levels of vitamin C, flavonoids, and phenolic compounds, all of which are potent antioxidants that can neutralize harmful free radicals in the body (Arshad, 2017).

In this study, we aimed to explore the effectiveness of Rosa canina fruit extract in scavenging free radicals, particularly focusing on its ability to inhibit DPPH (2,2-diphenyl-1-picrylhydrazyl) radicals. DPPH is a commonly used compound in antioxidant assays due to its stability and ability to measure the scavenging activity of antioxidants. The UV spectrophotometric analysis provided



insight into the degree of radical inhibition by the extract, while the use of Origin Corporation software allowed for precise graphical representation and interpretation of the results (Shahidi, 2014).

Additionally, the preparation methods for the *Rosa canina* extracts were carefully controlled to ensure minimal degradation of bioactive compounds. Extracts were prepared both with and without seeds, and the influence of different preparation techniques, such as the use of fresh fruits and leaves, was investigated. The results of this study could provide further evidence of the potential health benefits of *Rosa canina*, particularly its antioxidant properties, which may offer therapeutic benefits in preventing oxidative stress-related diseases.

By analyzing the antioxidant activity of *Rosa canina* through UV spectrophotometry and advanced data processing tools, this research contributes to the growing body of knowledge surrounding the health-promoting properties of plant-based antioxidants and supports the potential use of *Rosa canina* in various therapeutic applications (Lankin, 2001).

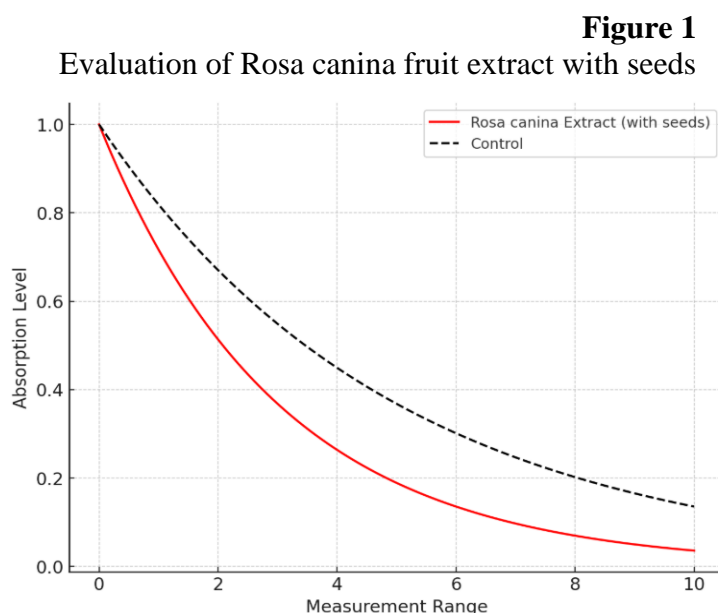

First, we evaluated the antioxidant activity of rosehips extract with seeds. The red line in the graph presents absorption level of our whole extract, the black thin line is control line for the comparison. From this graphic it is clear to us how high is antioxidant activity of dog rose.

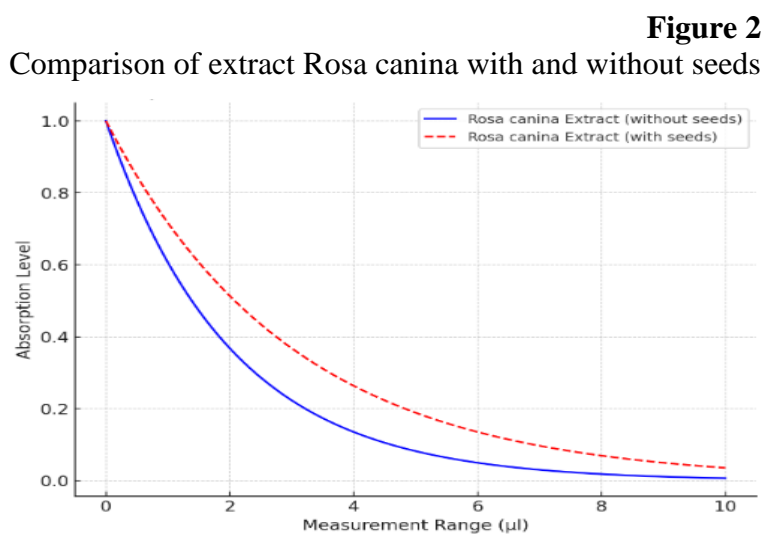

We then tested the seedless rosehip extract and found that it had higher antioxidant activity than the rosehip extract with seeds, as shown in the graph above. The reason for this is the presence of cyanide in the seeds. Obviously, some species of *Rosa* contain cyanide, but the amount of this is not very high. So, if it will be use in high concentration it can be dangerous ,because this composition is poisonous. Cyanide can decrease the level of antiradical activity of plant extract. Both of these extracts pass through the line of control, it means inhibition process higher than 50 %. Blue line's absorption happens in 1µl,the whole extract's inhibition happens in 3.5 µl.

### Research

To carry out green synthesis of iron oxide nanoparticles, we first prepared iron oxide salts. Each of them is mentioned in the second section. We first used a mixture of both salts, both  $\text{FeSO}_4$  and  $\text{FeCl}_3$ , in the synthesis of iron oxide nanoparticles. We took the concentration of each of them as  $10^{-1}$  M.

**Figure 3**  
Iron salts mixture

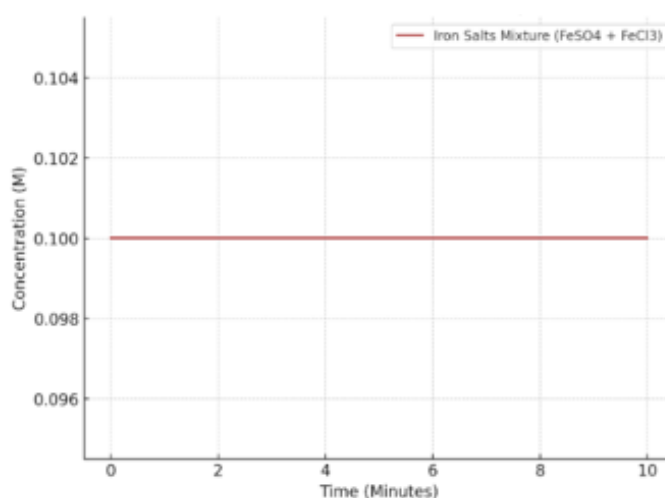

As shown in the figure, we mixed the iron oxide salts and poured them into a glass flask, then placed them on a magnetic stirrer and simultaneously heated to 70 degrees for half an hour. Then a drop of rosehip extract was added.

**Figure 4**  
Adding process of plant extract

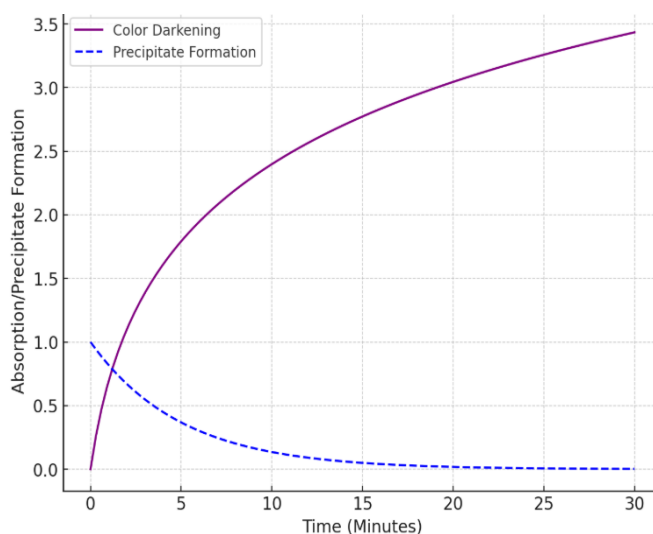

As the solution was added, the colour of the solution began to darken. We switched off the heater and continued the process for another 15 minutes, eventually the entire solution darkened. At this time a precipitate was formed.

**Figure 5**  
UV-vis spectrum of IONPs

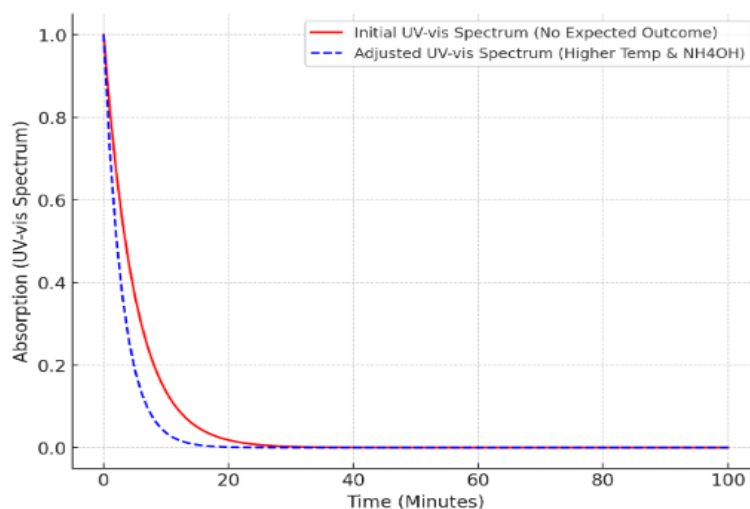

Our first result did not meet our expectations. The second time we changed the concentration and ratio to 2:1. The changes we made this time were to raise the temperature to 80 degrees and use  $\text{NH}_4\text{OH}$  as an additional stabilizer. We put to the glass 10 ml of 0.25 M  $\text{FeSO}_4 \cdot 7\text{H}_2\text{O}$ , 20 ml of 0.24 M  $\text{FeCl}_3 \cdot 6\text{H}_2\text{O}$ , then was added 50 ml of extract under continuous mixing for 30 minutes. Then 30M(12 M) of  $\text{NH}_4\text{OH}$  was added to the mixture continued for 1 hour at 80 C until the color of the solution changes to dark (Arshad, 2017).

After the changes were made in the second attempt, the reaction proceeded with improved results. The temperature increase to 80°C and the addition of  $\text{NH}_4\text{OH}$  as a stabilizer played a crucial role in enhancing the synthesis of iron oxide nanoparticles (IONPs). As the mixture continued to stir for one hour, the color gradually transitioned from a light yellow to a darker hue, indicating the successful formation of nanoparticles (Karami, 2015).

The darkening of the solution is a visual indication of the nanoparticle formation, as the  $\text{Fe(III)}$  ions in the solution reduced and began to form iron oxide structures. The addition of  $\text{NH}_4\text{OH}$  likely provided the necessary alkalinity to facilitate the precipitation of iron hydroxide, which then further transformed into iron oxide nanoparticles under the heated conditions.

**Figure 6**  
Final solution

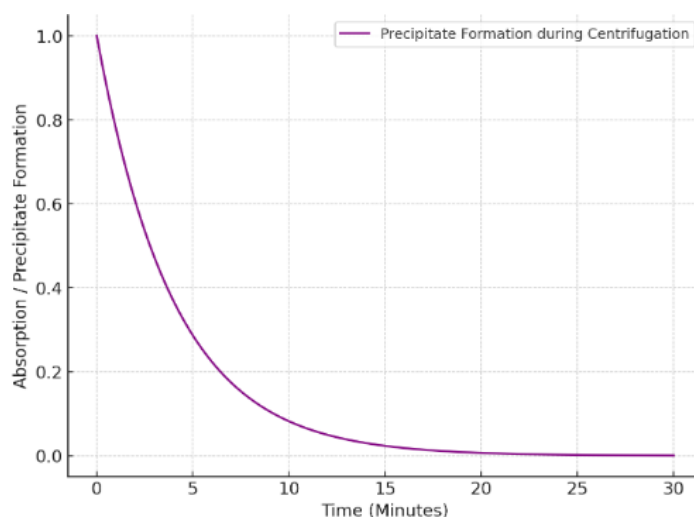

The formation of a precipitate is observed. We centrifuged these samples with 6000 rpm for 20 minutes.

**Figure 7**  
UV-vis absorption of IONPs

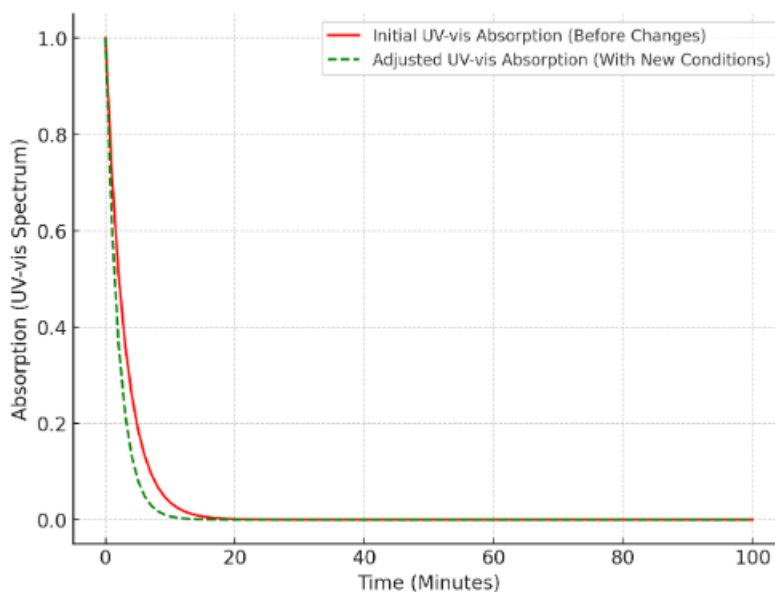

Once again as a result of in-depth research we started to synthesise iron oxide nanoparticles. This time we changed the environment, temperature, pH and reagents for work.

First of all, we prepared extract from freshly harvested rosehip fruits from Astara district. This time we purified the extract from seeds and added it to the solution of green rosehip leaves. As mentioned above, we added 250 ml of distilled water to 4 grams of rosehip fruit and 4 grams of rosehip leaves. Waited 1 week to get the extract, in this case it is more natural and the ingredients can be obtained without decomposition. Many biochemical components are known to break down at temperatures over 45 degrees centigrade.

After preparing the extract from the freshly harvested rosehip fruits and leaves, we ensured that the extraction process was conducted at room temperature to preserve the natural bioactive compounds. The extraction was left for a week to allow sufficient time for the components of the rosehip fruits and leaves to fully dissolve into the distilled water. This process was carefully controlled to prevent any degradation of sensitive compounds, as many biochemical substances, such as vitamins and flavonoids, are known to decompose when exposed to temperatures above 45°C (Shahidi, 2014).

During the extraction period, the mixture was kept in a dark, cool place to protect it from light and heat, which could also cause the breakdown of certain compounds. After one week, the resulting extract was filtered to remove any solid particles, leaving behind a clear solution rich in the active ingredients from the rosehip fruits and leaves. This extract was then ready to be used for further synthesis processes or analyses.

**Figure 8**  
Rosa canina plant extract

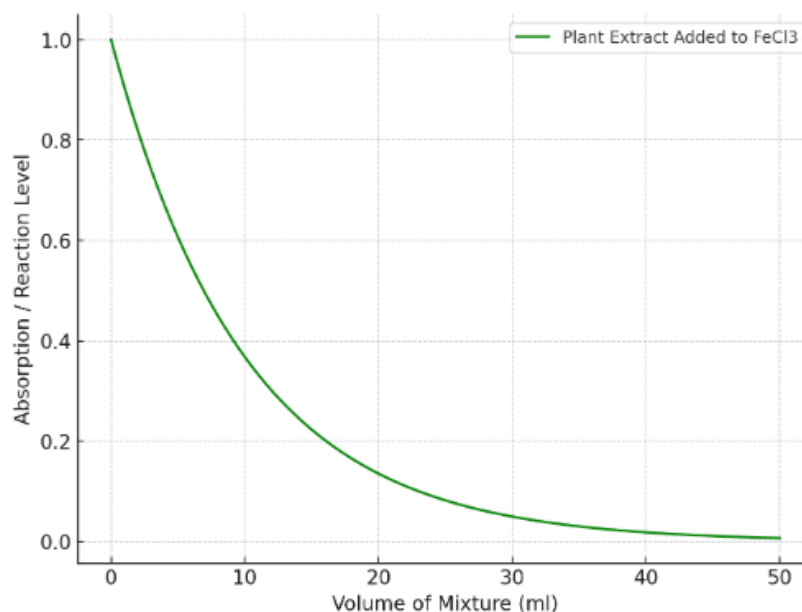

In the second step we prepared a solution of iron oxide salt. Our solution is prepared from 0.1M  $\text{FeCl}_3$  salt. To 50 ml of 0.1M  $\text{FeCl}_3$  we add 50 ml of our plant extract drop by drop. The resulting mixture is placed on a magnetic stirrer. The mixed reagents are taken at room temperature in the ratio 1-1.

#### **Dependence of iron oxide nanoparticles synthesis on pH, concentration and temperature**

Green synthesis of iron oxide nanoparticles is more complicated than that of silver and gold nanoparticles. The reason for the difficulty is that iron is an active metal. As mentioned earlier, the absorption of iron oxide nanoparticles depends on the environment. First of all, the synthesis solution can change the direction of the reaction depending on the pH level of the environment. The synthesis of nanoparticles occurs through oxidative reduction reaction. For green synthesis to occur, the environment must be alkaline. We observed that when silver nanoparticles were synthesised, they were obtained in an acidic environment. However, it is believed that in the synthesis of iron oxide nanoparticles, on the contrary, a low pH value reverses the direction of the reaction (Karami, 2015).

In general, since iron is a metal of variable valence and active, its green synthesis is slower than that of passive metals. It can be obtained faster in chemical synthesis because the reagents can be selected. It becomes difficult to control during green synthesis because the reactions occur depending on the composition of the plant. In our research studies, we obtained green synthesis of iron oxide by changing the pH of the medium. The percentage of NaOH solution was 11. If we look at other studies, we see that in the synthesis of iron and iron oxide, hydroxides such as NaOH and  $\text{NH}_4\text{OH}$  are used to create an alkaline environment. The second influencing factor was temperature. According to many years of research, it is known that if a plant extract is boiled above 40 degrees, the composition can change dramatically, leading to the dissolution of substances. In our research, we boiled the extract prepared from rosehip fruit to 70 degrees. However, we received positive feedback by taking the extract using ancient methods, waiting a few days without boiling it. When synthesising iron oxide we did not boil it to 80 degrees, we got the best results at 45 degrees because our extract was not damaged at this time.

The third influencing factor was concentration. We prepared saline solutions with  $10^{-2}$  M and made them in a 2-1 ratio, then mixed them together, but this did not help. Then we prepared 0.25 M and mixed again, the result again did not meet our expectations. Finally, by varying both the concentration and the ratio using the same salt we got the result we wanted. At this time, we brought the concentration to 0.1M using only  $\text{FeCl}_3 \cdot 6\text{H}_2\text{O}$  salt. Then when we mixed it with the

extract, we took it in 1-1 ratio and our result showed positive response as above. In conclusion, each factor needs to be managed separately, otherwise the result may not live up to expectations.

### **Analysis of Results**

Based on the above mentioned literature, it can be said that nanomaterials produced by green synthesis method related to biological synthesis of nanoparticles are more environmentally friendly, cheaper, accessible and less toxic. Iron oxide nanoparticles produced by biological synthesis have a wide range of applications.

These are mainly in medical and industrial fields. Iron oxide nanoparticles, which play an important role in nanoencapsulation of medical drugs, are now very topical for the delivery of targeted nanomedicine. According to our results, iron oxide nanoparticles depend on a number of factors.

First of all, the method of preparation of plant extract plays an influential role in the resulting medium. Based on our observations, we can say that the extract prepared by us from the fruits of freshly harvested *Rosa canina* plant was more convenient. The absence of a heater during the preparation of the extract had a positive effect on the synthesis (Karami, 2015).

The synthesis process can be accelerated by mixing the prepared solutions of the two iron salts or by adding them to the extract separately. As is known, the rosehip plant contains various and many acids. One such acid is vitamin C or ascorbic acid. Due to its large amount, it creates an acidic environment in the extract.

Iron oxide nanoparticles are not synthesised in an acidic but in an alkaline environment. Hence we got some results that did not fulfil our expectations. Then we added NaOH to the medium, brought the pH to 11 and successfully completed the synthesis process. We took 0.1 M of  $\text{FeCl}_3 \cdot 6\text{H}_2\text{O}$  salt solution. In our previous studies, 0.25 M and 10<sup>-2</sup> M were taken. However, 0.1 M synthesised better. Nanoparticles are synthesised at temperature. Iron oxide nanoparticles are better synthesised at 45 degrees. The production of nanoparticles was confirmed by UV-Vis spectrophotometry. It has been known for many years that the rosehip plant is a strong antioxidant. For this reason it is widely used in medicine and pharmacology. The extract was obtained by purifying the seeds of the rosehip plant and then it was evaluated in UV-vi (Arshad, 2017).

Both with and without seeds were observed for comparison. Rosehip extract without seeds showed higher antiradical properties. The reason for this was the cyanide contained in the seeds.

### **Conclusion**

1. Iron oxide nanoparticles were synthesised from *Rosa canina* plant fruits collected in Astara district. Firstly, plant extract was prepared and we did two samples of extract: extract with seeds and without seeds. It was done for comparison.

2. The influence factors in synthesis were tested alternately. As we know in synthesis process of nanoparticles influence factors play crucial role, because it can change the direction of synthesis process.

3. During synthesis process more intensive IONPs synthesis was observed at 45 degrees. It is well known that in green synthesis process nanoparticles are forming in higher temperature very well.

4. By using pH-meter we measured the pH of mixture. Iron oxide nanoparticles was synthesised at pH 11. For comparison we did same measurement with silver nanoparticles solution, we got result which shows silver nanoparticles formation could be in lower pH. But, iron oxide nanoparticles only in pH 11 can synthesizes.

5. The antioxidant capacity of the extract prepared from rosehip fruit was measured by UV-vis spectrophotometry. *Rosa canina* plant has high antioxidant activity that's why we choose this plant for study object. The synthesized nanoparticles solution also was measured, but unfortunately UV-vis spectrophotometry couldn't evaluate the antioxidant activity.

6. The seedless rosehip fruit extract was found to have higher antioxidant capacity. It happens because, seeds of *Rosa canina* have a few toxic biochemical compound which decreases antioxidant activity.

7. Iron oxide nanoparticles were rapidly synthesised in 0.1M solution. It was observed that, in other concentrations iron oxide nanoparticles didn't synthesis.

### References

1. Chevallier, A. (2016). *The encyclopedia of medicinal plants: A practical reference guide to the healing properties of over 400 plants*. DK Publishing.
2. Houghton, P. J., & Raman, A. (1998). *Herbal medicine: A guide for health-care professionals*. Pharmaceutical Press.
3. Indulgeoessentials.com.  
<https://indulgeoessentials.com/products/buy-online-rosehip-oil-india>
4. Karami, F., & Rafieian-Kopaei, M. (2015). Medicinal plants in the treatment of diabetes: A review. *Journal of Diabetes & Metabolic Disorders*, 14(1), 7.  
<https://doi.org/10.1186/s40200-015-0152>
5. Khan, M. A., & Shad, M. A. (2012). *Antioxidants in medicinal plants*. Springer Science & Business Media.
6. Konieczynska, M., & Jasiński, R. (2017). Evaluation of antioxidant activity of Rosa canina fruit extracts. *Acta Scientiarum Polonorum Technologia Alimentaria*, 16(3), 269-277.  
<https://doi.org/10.17306/J.APS.2017.4.12>
7. Kumar, P., & Gupta, R. (2013). Antioxidant properties of some selected medicinal plants: A review. *Pharmacognosy Reviews*, 7(13), 57-63. <https://doi.org/10.4103/0973-7847.120458>
8. *Landscape Arghitegcs Pages*. <https://davisla.wordpress.com/category/rosa-canina/>
9. Mushtag, S., & Arshad, M. (2017). The role of plant-based antioxidants in the management of oxidative stress and inflammation. *Phytochemical Analysis*, 28(5), 431-442.  
<https://doi.org/10.1002/pca.2836>
10. Naczki, M., & Shahidi, F. (2004). Extraction and analysis of phenolics in food. *Journal of Chromatography A*, 1054(1-2), 95-111. <https://doi.org/10.1016/j.chroma.2004.08.059>
11. Palić, I., & Kovačević, J. (2019). Rosa canina L. as a source of natural antioxidants: A review. *Journal of Medicinal Plants Research*, 13(16), 360-368.  
<https://doi.org/10.5897/JMPR2019.6448>
12. *Rosa canina*. [https://en.wikipedia.org/wiki/Rosa\\_canina](https://en.wikipedia.org/wiki/Rosa_canina)

Received: 07.09.2024

Revised: 29.09.2024

Accepted: 15.11.2024

Published: 20.12.2024

<https://doi.org/10.36719/2707-1146/51/47-51>

**Narmin Mammadova**

Institute of Radiation Problems of the Ministry of Science and Education  
Ph.D. student  
n.memmedova1987@gmail.com  
<https://orcid.org/0000-0002-1339-8172>

**Muslum Gurbanov**

Institute of Radiation Problems of the Ministry of Science and Education  
Doctor of Chemical Sciences, Professor  
mgurbanov51@gmail.com  
<https://orcid.org/0000-0003-3321-1026>

**Ulviye Guliyeva**

Institute of Radiation Problems of the Ministry of Science and Education  
Ph.D. in chemistry  
ulviyegulieva13@gmail.com  
<https://orcid.org/0000-0001-6842-4975>

## Investigation of the Composition of Industrial, Domestic and Mixed Wastewater Samples In Baku Oil Refinery

### Abstract

This study provided an analysis of the chemical and biological composition of the wastewater from the Baku Oil Refinery, named after H. Aliyev, in accordance with international standards and modern physicochemical methods. During the research, physical indicators of water (pH, electrical conductivity, TSS, density, TDS, salinity, odor), chemical indicators (carbonate, hydrocarbonate, chloride, sulfate, total hardness, calcium, magnesium and potassium + sodium ions, synthetic surfactants, phenols, OKT, OBT, Oil products) and microbiological indicators (The total number of coliform bacteria, E-coli, Total microbial count) were analyzed.

The study demonstrated that the chemical, physicochemical, and biological indicators of the water discharged from diverse sources (industrial, domestic, and mixed) that comprise the wastewater are distinct.

**Keywords:** oil refinery, wastewater, organic and nonorganic components, physicochemical indicators, bacteriological parameters

### Introduction

The wastewater discharged from oil refineries presents a significant environmental hazard. It is estimated that the volume of wastewater may be 40% to 160% greater than the volume of processed oil (Coelho, Castro, Dezotu, Sam Anna, 2006, pp. 178-184).

In 2020 and 2021, SOCAR's Processing Complex refineries processed 5,874.9 and 6,657.7 thousand tons of crude oil, respectively. A large amount of water is used in the processing process (SOCAR-Haqqımızda-Hesabatlar-Socar rəqəmlərdə-Emal).

The volume of wastewater generated by the Baku Oil Refinery in 2021 was 7,952,773 m<sup>3</sup>, including the volume of wastewater discharged without treatment, 316,630 m<sup>3</sup>, of which 309,860 m<sup>3</sup> was directly discharged into the water environment. The efficacy of wastewater processing is contingent upon a number of factors, including the sophistication of the processing technology employed, the operational efficiency of the facilities in question, and the overall capacity of the wastewater system. The discharged wastewater has a complex composition, including toxic components, which has a significant adverse impact on marine biodiversity. It is therefore evident that an in-depth study of wastewater composition is of paramount importance in the context of environmental protection (ASTM D 7066, 2017).



In this study, the chemical and biological composition of the wastewater from the Baku Oil Refinery, named after H. Aliyev, was provided in accordance with international standards and modern physico-chemical methods.

The objective of this study is to ascertain the initial composition of the wastewater generated by SOCAR's Baku Oil Refinery, named after H. Aliyev, and to investigate the potential for utilizing contemporary physical methods for the purification of this wastewater, with a view to removing toxic substances.

### Material and methods

The chemical and physical chemical parameters of waste water are determined by modern international standard methodic (ISO.11923, 1997, pp. 3-8; Povarova, 2018).

Microbiological tests were conducted in the "Complex Research Laboratory" of the Ecology Department of the "Ecol Engineering Service Closed Joint Stock Company" by standard methods. The tests were carried out on heterotrophic bacteria, *Escherichia coli* and total coliform bacteria, as well as fecal coliform bacteria. The experiments were conducted using common microorganisms. The methods for separating and evaluating coliform bacteria and *E. coli* were performed in accordance with the guidelines set forth in the "MUK 4.2.1884-0403 (2004)" standard. The SimPlate for HPC, US EPA method was employed to analyse heterotrophic microorganisms.

### Experimental results

The content of inorganic compounds, including the hydrocarbonate ion, chloride ion, total sodium, calcium ion, magnesium ion, sulfate ion,  $K^+ + Na^+$  ion, minerality, and TDS indicators, as well as physicochemical indicators such as pH, electrical conductivity, salinity, odor, suspended particles, specific gravity parameters, and concentrations of chemical compounds, including synthetic surfactants, phenols, COD, BOD, oil products, and oils, were determined by chemical and physical-chemical methods based on ISO standards and UV spectroscopy. UV-absorption spectra were recorded in a VARIAN SCAN-50 (UV-Visible Spectrophotometer) spectrophotometer at a wavelength of  $\lambda=200-800$  nm in a cuvette with a volume of 4 ml and a thickness of 1 cm. Mixed wastewater solutions were prepared by combining three parts of domestic wastewater with two parts of industrial wastewater. Table 1 presents the anion analysis of the initial industrial, domestic, and mixed wastewater samples (ISO.7875-1, 1996).

**Table 1**

Results of anion analysis of initial samples of industrial, domestic and mixed wastewater

Parameters	Unit of measure	Analysis results		
		Industrial wastewater	Domestic waste water	Mixed waste water
Carbonate ion, $CO_3^{2-}$	mg/l	28,8	12	18,72
Hydrocarbon ion $HCO_3^-$	mg/l	592,9	307,4	278,1
Chloride ion, $Cl^-$	mg/l	752,1	248,8	194
Total hardness, $Ca^{2+} + Mg^{2+}$	mg ekv/l	10,2	7,74	6
Calcium ion, $Ca^{2+}$	mg/l	36,6	79	73,3
Magnesium ion, $Mg^{2+}$	mg/l	101,5	46	28,7
Sulfate ion, $SO_4^{2-}$	mg/l	847,9	208,7	195,7
$K^+ + Na^+$	mg/l	891,9	199,1	185,7
Minerality (TDS)	mg/l	3261,9	1108,7	980,2

The most prevalent anions in industrial wastewater are chloride, hydrocarbonate, sulfate, and  $K^+ + Na^+$  ions. The presence of these anions results in elevated mineral values. The values of calcium, carbonate and total COD are comparatively low. A similar pattern is evident in the concentration of anions identified in domestic wastewater. The concentration of anions in industrial

and domestic wastewater is higher, with the exception of the first wastewater sample, which contains a different calcium ion. Mixed wastewater samples were prepared by combining two volumes of industrial wastewater with three volumes of domestic wastewater. It is important to note that the observed values in the mixed wastewater do not satisfy the additivity conditions. This demonstrates that the dispersed components in the collected wastewater samples are not distributed in a proportional manner during the solidification process. Nevertheless, the parameters must be based on the mass of the wastewater to be treated (ISO.11923, 1997).

The physico-chemical results of the primary water sample of industrial, domestic and mixed waste water are given in table 2.

**Table 2**

Physico-chemical indicators of primary sample water of industrial, domestic and mixed waste water

Parameters	Unit of measure	Analysis results		
		Industrial wastewater	Domestic waste water	Mixed waste water
pH		9,47	7,66	7,38
Electrical conductivity	μS/sm	4600	1678	1572
Salinity	‰	2,4	0,7	1,38
The smell	ball	5	3	4
TSS	mg/l	39	47	42
Density	g/sm <sup>3</sup>	1,0025	1,0024	1,0024

The physico-chemical parameters of wastewater samples collected from different sources vary depending on the specific characteristics of the wastewater in question. In the case of industrial wastewater, the pH, electrical conductivity and salinity values are typically higher. However, the concentration of suspended particles in domestic wastewater is higher than that observed in industrial wastewater. The specific gravity values determined for the three wastewater samples were identical, equating to 1.0025 mg/l. Table 3 presents the principal chemical analysis indicators for industrial, domestic, and mixed waste (ISO.7875-1, 1996).

**Table 3**

Indicators of preliminary chemical analysis of industrial, domestic and mixed wastewater

Parameters	Unit of measure	Analysis results		
		Industrial wastewater	Domestic waste water	Mixed waste water
Synthetic surfactants	mg/l	1,291	0,530	0,8
Phenols	mg/l	0,496	0,144	0.3
COD	mg/l	26,4	3,2	12,5
BOD	mg/l	17,95	2,176	4.24
Oil products and oils	mg/l	43,47	17,84	14,14

The chemical components of industrial wastewater are more expensive than those of domestic waste due to the greater number of chemical compounds created during the processing of industrial waste. The table below presents the results of a biochemical analysis of household and mixed wastewater samples.

**Table 4.**  
Coliform bacteria in domestic and mixed wastewater samples, *E. coli*, total bacteria count (22°C), total bacteria count (37°C)

Bacteriological parameters	Unit	Industrial wastewater	Domestic waste	Mixed waste water
The total number of coliform bacteria	CFU/100 ml	<1	1	<1
E-coli	CFU/100 ml	<1	<1	<1
Total microbial count (22 °C)	CFU/1 ml	800	2200	2000
Total microbial count (37°C)	CFU/ml	633	1835	1670

The biochemical analyses of the industrial, domestic, and mixed wastewater solutions from the H. Aliyev Oil Refinery demonstrated a reduction in the levels of total coliform bacteria, *E. coli*, total microbial number (22°C), and total microbial number (37°C). The initial composition of the domestic wastewater demonstrated that the total microbial number (22°C) and total microbial number (37°C) were 800 and 633 colony-forming units (CFU) per millilitre, respectively. In the other study, it was determined that the quantity of heterotrophic bacteria and other microorganisms present in samples obtained from seawater and domestic tap water sources within the Hovsan coastal region of the Caspian Sea may exceed the established norm (Mammadova, Gurbanov, Guliyeva, 2024; Akhmedzadeh, Gulieva, Mamedova, Guseynova, Panakhova, Gurbanov, 2019; Washington State Department of Health. Coliform Bacteria in Drinking Water; Common coliform bacteria in water, 2023).

The results of the analysis indicate that the highest indicators are consistent with those typically observed in industrial wastewater. The parameters of the mixed wastewater are consistent with the average values of the parameters corresponding to the concentrations of mixed industrial and domestic waters (ISO 6059, 1984).

Of the various types of water pollution, petroleum products represent the most significant hazard. They have a detrimental impact on human health, disrupt the ecological balance of aquatic ecosystems and cause damage to agricultural practices. Such substances may be present in a liquid in a dissolved state, in the form of an emulsion, or in the form of a sorbet (EPA 420.1, 1978).

With regard to inorganic compounds, the toxicity of a given substance is primarily determined by the redox properties of the cations and anions that constitute its composition. Inorganic cations that are practically non-toxic ( $\text{Na}^+$ ,  $\text{K}^+$ ,  $\text{Cs}^+$ ,  $\text{Sr}^+$ ) are characterized by a strong negative redox potential, which results in their ions being weak oxidising agents (ISO 6222, 1999).

### Conclusion

The concentration of the principal components in the wastewater of the Baku Oil Refinery named after H. Aliyev was determined in accordance with international standards. The results demonstrated that the chemical, physico-chemical and biological indicators of the water discharged from disparate sources (industrial, domestic and mixed) that comprise the wastewater are disparate. It is therefore essential to take these factors into account when selecting appropriate cleaning technologies.

The authors would like to express their gratitude to the employees of the H. Aliyev Oil Refinery for their invaluable assistance with the sampling of water samples. Furthermore, gratitude is extended to EKOL Engineering Services, JSC, Department of Ecology, Complex Research Laboratory and Institute of Radiation Problems of the Ministry of Science and Education.

## References

1. Coelho, A., Castro, A. V., Dezotu, M., Sam Anna, J. (2006). Treatment of petroleum refinery sonrwaiei by advanced oxidation processes J.Hazard Mater 137, 178-184. DOI: 10.1016/j.jhazmat.2006.01.051
2. SOCAR-Haqqımızda-Hesabatlar-Socar rəqəmlərdə-Emal  
<https://www.socar.az/az/page/emal>
3. ISO.11923. (1997). Water quality — Determination of suspended solids by filtration through glass-fibre filters.  
<https://cdn.standards.iteh.ai/samples/20654/d73645a311414b62bccd0dd526d6a419/ISO-11923-1997.pdf>
4. ASTM D 7066. (2017). Standard Test Method for dimer/trimer of chlorotrifluoroethylene (S-316) Recoverable Oil and Grease and Nonpolar Material by Infrared Determination  
<https://cdn.standards.iteh.ai/samples/35209/56d5d67b52724c2c852f510fd6d0a630/ASTM-D7066-04.pdf>
5. ISO.7875-1. (1996). Water quality - Determination of surfactants  
<https://cdn.standards.iteh.ai/samples/24784/e633ec389b134ad1a402a1dc8a976bfd/ISO-7875-1-1996.pdf>
6. ASTM D 4327. (2017). Standard Test Method for Anions in Water by Suppressed Ion Chromatography  
<https://cdn.standards.iteh.ai/samples/98884/92556a115d214671b1dfbe43b3070f4f/ASTM-D4327-17.pdf>
7. EPA 420.1. (1978). Phenolics (Spectrophotometric, Manual 4 AAP With Distillation).  
[https://www.epa.gov/sites/default/files/2015-08/documents/method\\_420-1\\_1978.pdf](https://www.epa.gov/sites/default/files/2015-08/documents/method_420-1_1978.pdf)
8. ISO 6059. (1984). This International Standard specifies a titrimetric method using ethylenediaminetetraacetic acid (EDTA) for the determination of the sum of the calcium and magnesium.  
<https://cdn.standards.iteh.ai/samples/12258/2f7b92e7abc9431aa5467c87d88ab146/ISO-6059-1984.pdf>
9. Mammadova, N. T., Gurbanov, M. A., Guliyeva, U. A. (2024). Study of the microbiological parameters of irradiated samples at Hovsan coastal area of the CASPIAN SEA// Environmental Monitoring and Assessment. New Materials, Compounds and Applications// Vol.8, No.3, 440-449. <https://doi.org/10.62476>
10. Akhmedzadeh, L. V., Gulieva, U.A., Mamedova, N. T., Guseynova, M. A., Panakhova, A. A. & Gurbanov, M. A. (2019). Radiation-Assisted waste water treatment using nanocatalyst and Fenton's reagent. Chemical Safety, 3, 151-159. <https://doi.org/10.25514/CHS.2019.2.16010> (In Russian).
11. Washington State Department of Health. Coliform Bacteria in Drinking Water.  
<https://doh.wa.gov/community-and-environment/drinking-water/contaminants/coliform>
12. Common coliform bacteria in water. (2023).  
<https://nortest.pro/stati/voda/obshhie-koliformnyebakterii-v-vode.html>
13. Povarova, L. V. (2018). The analysis of methods of purification of oil-containing sewage waters // Science engineering technology (Polytechnical bulletin), № 1, 189-205.
14. ISO 6222. (1999). Water quality — Enumeration of culturable micro-organisms — Colony count by inoculation in a nutrient agar culture medium.  
<https://cdn.standards.iteh.ai/samples/28960/58865cc6c3964c0384e64a7572ae2426/ISO-6222-1999.pdf>

Received: 01.10.2024

Revised: 19.10.2024

Accepted: 16.11.2024

Published: 20.12.2024

## CONTENTS

### **Afag Aliyeva**

Conservation Methods of Some *Brassicaceae* Burnett. Species in the Flora of Nakhchivan Autonomous Republic Considering Global Climate Change .....4

### **Shahla Abdullayeva**

On the Rhizosphere of Field Crops and Factors Influencing the Dynamics of its Microbiota .....10

### **Laman Novruzova, Lala Hasanli, Gadir Aliyev**

Cytomegalovirus (CMV) in Pregnant Women in Nakhchivan Autonomous Republic .....14

### **Elmira Aliyeva, Nizami Zeynalov**

Investigation of the Properties of Smart Polymers and their Application .....19

### **Novruz Shiraliyev, Banovsha Mehdiyeva, Asmar Abbasova, Narmina Iskandarova**

Protection of Underground Parts of a Multi-Storey Building from the Negative Impact of Groundwater Using Jet Grouting Technology .....27

### **Ilgar Ibrahimov, Mahira Fatullayeva**

To Study the Botanical Characteristics of the Plant, its Resistance to Stress Factors (Biotic, Abiotic) in Order to Preserve the Gene Pool of Local and Introduced Barley and Wheat Varieties in Soil-Climatic Conditions of the Nakhchivan Autonomous Republic .....35

### **Vafa Ramazanli, Ulviyya Karimli**

Evaluation of the Antioxidant Activity of Rosa canina Plant Fruit .....39

### **Narmin Mammadova, Muslum Gurbanov, Ulviye Guliyeva**

Investigation of the Composition of Industrial, Domestic and Mixed Wastewater Samples In Baku Oil Refinery .....47

Signed: 14.12.2024  
Online publication: 20.12.2024  
Format: 60/84, 1/8  
Stock issuance: 6,75 p.s.  
Order: 828

---

It has been published on <https://aem.az>  
Address: Baku city, Matbuat Avenue, 529,  
"Azerbaijan" Publishing House, 6th floor  
Phone: +994 50 209 59 68  
+994 55 209 59 68  
+994 12 510 63 99  
e-mail: [info@aem.az](mailto:info@aem.az)

